

V_{DSM}	=	1800 V
I_{TAVM}	=	730 A
I_{TRMS}	=	1150 A
I_{TSM}	=	9000 A
V_{T0}	=	0.80 V
r_T	=	0.540 mΩ

Phase Control Thyristor

5STP 07D1800

Doc. No. 5SYA1027-05 Sep. 01

- Patented free-floating silicon technology
- Low on-state and switching losses
- Designed for traction, energy and industrial applications
- Optimum power handling capability

Blocking

Part Number	5STP 07D1800	5STP 07D1600	5STP 07D1200	Conditions
V_{DRM} V_{RRM}	1800 V	1600 V	1200 V	$f = 50 \text{ Hz}$, $t_p = 10 \text{ ms}$
V_{RSM1}	2000 V	1800 V	1400 V	$t_p = 5 \text{ ms}$, single pulse
I_{DRM}	$\leq 100 \text{ mA}$			V_{DRM}
I_{RRM}	$\leq 100 \text{ mA}$			V_{RRM}
dV/dt_{crit}	1000 V/ μs			Exp. to $0.67 \times V_{DRM}$, $T_j = 125^\circ\text{C}$

Mechanical data

F_M	Mounting force	nom.	10 kN
		min.	8 kN
		max.	12 kN
a	Acceleration		
	Device unclamped		50 m/s ²
	Device clamped		100 m/s ²
m	Weight		0.3 kg
D_S	Surface creepage distance		25 mm
D_a	Air strike distance		14 mm



ABB Semiconductors AG reserves the right to change specifications without notice.

On-state

I_{TAVM}	Max. average on-state current	730 A	Half sine wave, $T_C = 70^\circ\text{C}$	
I_{TRMS}	Max. RMS on-state current	1150 A		
I_{TSM}	Max. peak non-repetitive	9000 A	$t_p = 10\text{ ms}$	$T_j = 125^\circ\text{C}$
	surge current	9500 A	$t_p = 8.3\text{ ms}$	After surge:
I^2t	Limiting load integral	405 kA^2s	$t_p = 10\text{ ms}$	$V_D = V_R = 0\text{V}$
		374 kA^2s	$t_p = 8.3\text{ ms}$	
V_T	On-state voltage	1.60 V	$I_T = 1500\text{ A}$	$T_j = 125^\circ\text{C}$
V_{T0}	Threshold voltage	0.80 V	$I_T = 500 - 1500\text{ A}$	
r_T	Slope resistance	0.540 $\text{m}\Omega$		
I_H	Holding current	20-70 mA	$T_j = 25^\circ\text{C}$	
		10-50 mA	$T_j = 125^\circ\text{C}$	
I_L	Latching current	80-500 mA	$T_j = 25^\circ\text{C}$	
		50-200 mA	$T_j = 125^\circ\text{C}$	

Switching

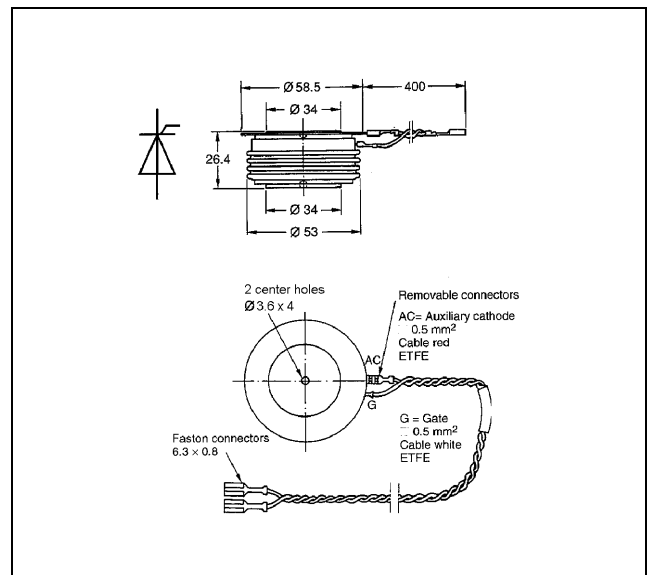
di/dt_{crit}	Critical rate of rise of on-state current	150 $\text{A}/\mu\text{s}$	Cont. $f = 50\text{ Hz}$	$V_D \leq 0.67 \cdot V_{DRM}$, $T_j = 125^\circ\text{C}$ $I_{TRM} = 1500\text{ A}$ $I_{FG} = 2\text{ A}$, $t_r = 0.5\ \mu\text{s}$
		300 $\text{A}/\mu\text{s}$	60 sec. $f = 50\text{ Hz}$	
t_d	Delay time	$\leq 3.0\ \mu\text{s}$	$V_D = 0.4 \cdot V_{DRM}$	$I_{FG} = 2\text{ A}$, $t_r = 0.5\ \mu\text{s}$
t_q	Turn-off time	$\leq 400\ \mu\text{s}$	$V_D \leq 0.67 \cdot V_{DRM}$ $dv_D/dt = 20\text{V}/\mu\text{s}$	$I_{TRM} = 1500\text{ A}$, $T_j = 125^\circ\text{C}$ $V_R > 200\text{ V}$, $di_T/dt = -20\text{ A}/\mu\text{s}$
Q_{rr}	Recovery charge	min	800 μAs	
		max	1500 μAs	

Triggering

V_{GT}	Gate trigger voltage	2.6 V	$T_j = 25^\circ$
I_{GT}	Gate trigger current	400 mA	$T_j = 25^\circ$
V_{GD}	Gate non-trigger voltage	0.3 V	$V_D = 0.4 \times V_{DRM}$
I_{GD}	Gate non-trigger current	10 mA	$V_D = 0.4 \times V_{DRM}$
V_{FGM}	Peak forward gate voltage	12 V	
I_{FGM}	Peak forward gate current	10 A	
V_{RGM}	Peak reverse gate voltage	10 V	
P_G	Gate power loss	3 W	

Thermal

T_{jmax}	Max. operating junction temperature range	125 °C	
T_{stg}	Storage temperature range	-40...140 °C	
R_{thJC}	Thermal resistance junction to case	70 K/kW	Anode side cooled
		74 K/kW	Cathode side cooled
		36 K/kW	Double side cooled
R_{thCH}	Thermal resistance case to heat sink	15 K/kW	Single side cooled
		7.5 K/kW	Double side cooled

Analytical function for transient thermal impedance:

$$Z_{thJC}(t) = \sum_{i=1}^n R_i(1 - e^{-t/\tau_i})$$

i	1	2	3	4
$R_i(K/kW)$	19.18	9.82	5.45	1.44
$\tau_i(s)$	0.3862	0.0561	0.0058	0.0024

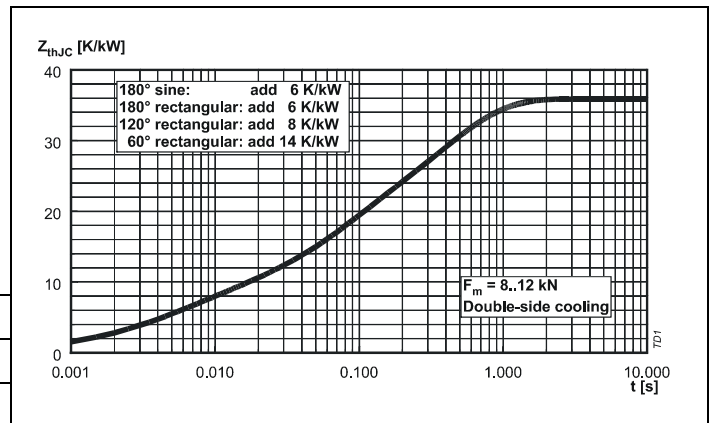

Fig. 1 Transient thermal impedance junction to case.

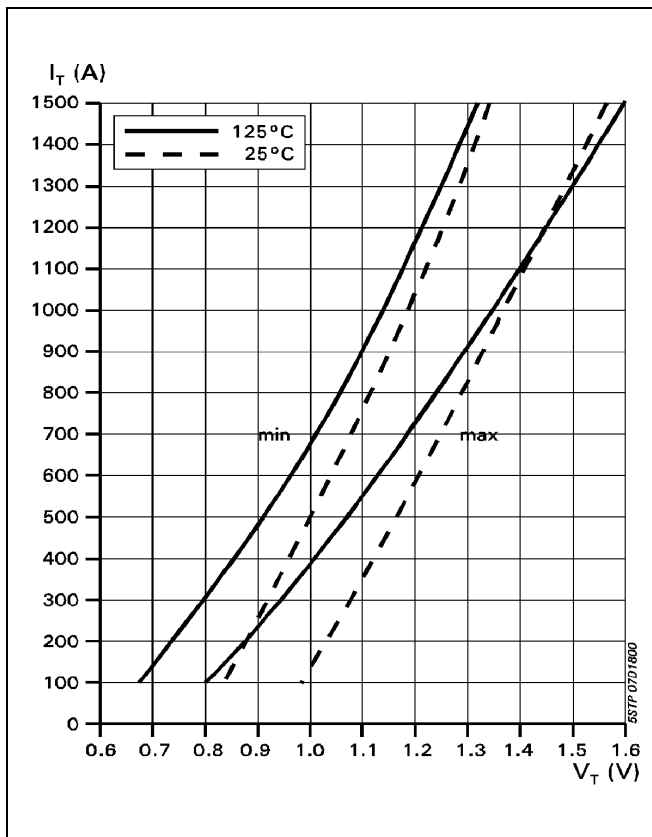

Fig. 2 On-state characteristics.

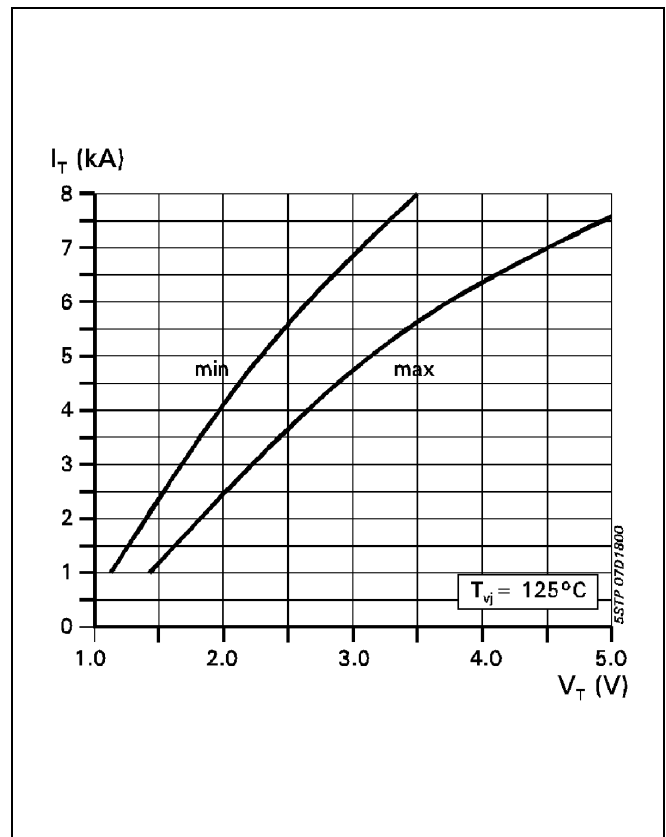

Fig. 3 On-state characteristics. $T_{vj}=125^{\circ}C$, 10ms half sine

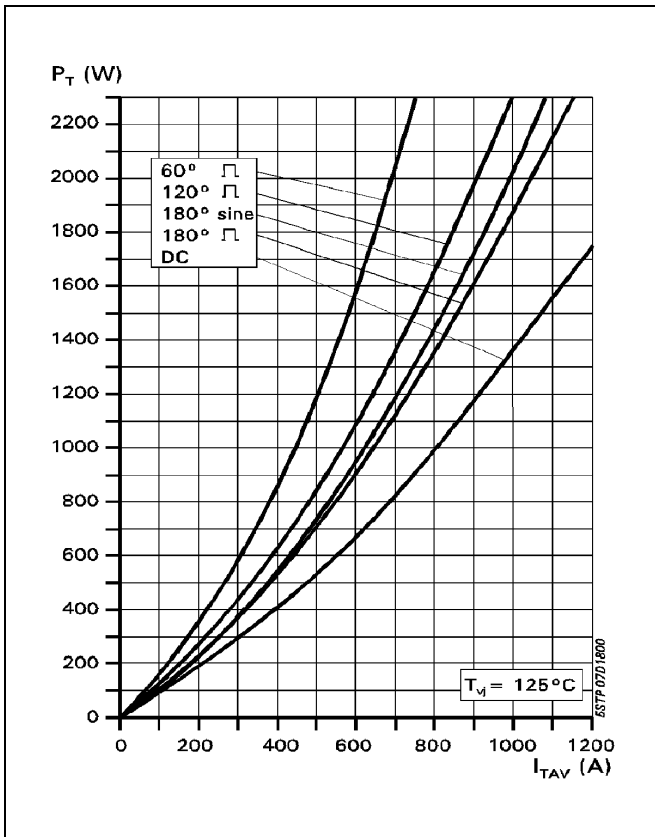

Fig. 4 On-state power dissipation vs. mean on-state current. Turn - on losses excluded.

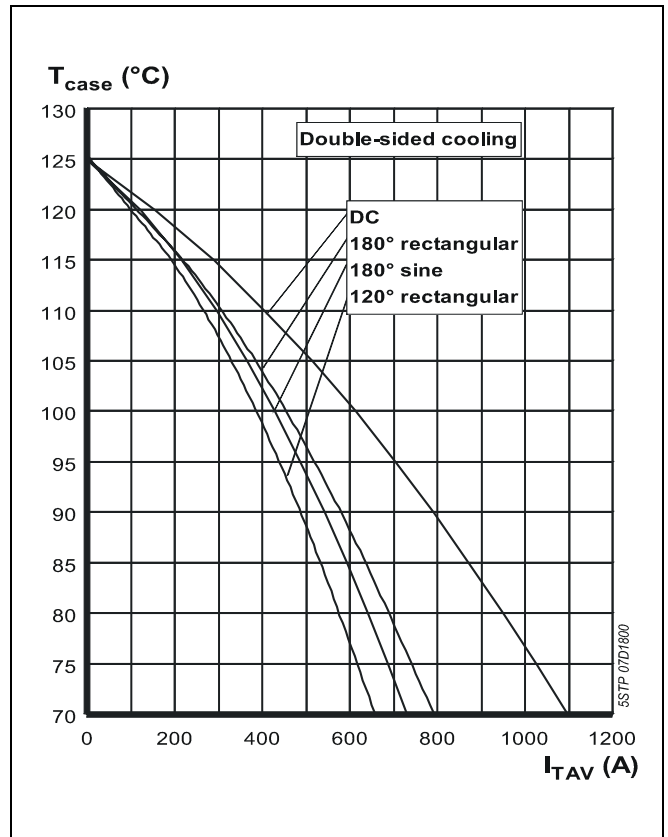

Fig. 5 Max. permissible case temperature vs. mean on-state current.

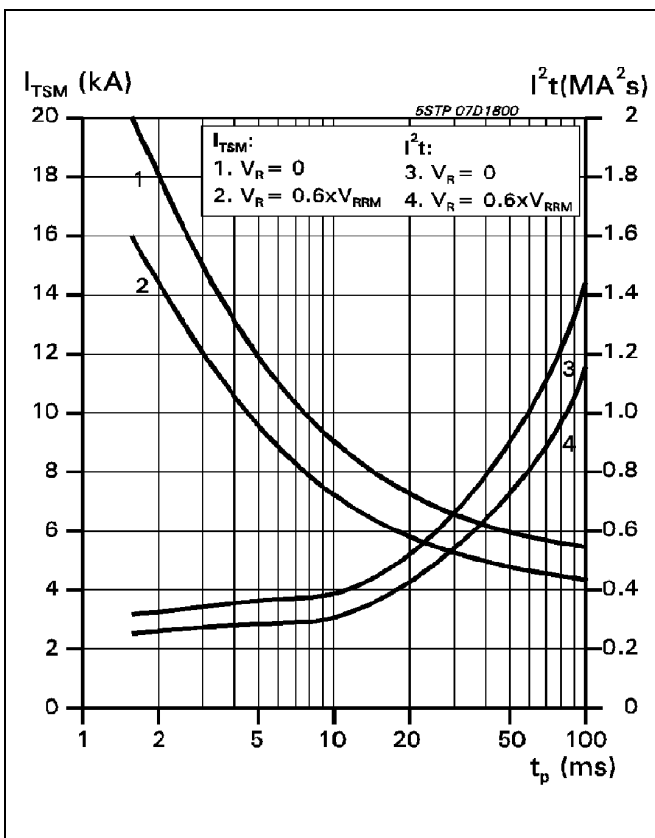

Fig. 6 Surge on-state current vs. pulse length. Half-sine wave.

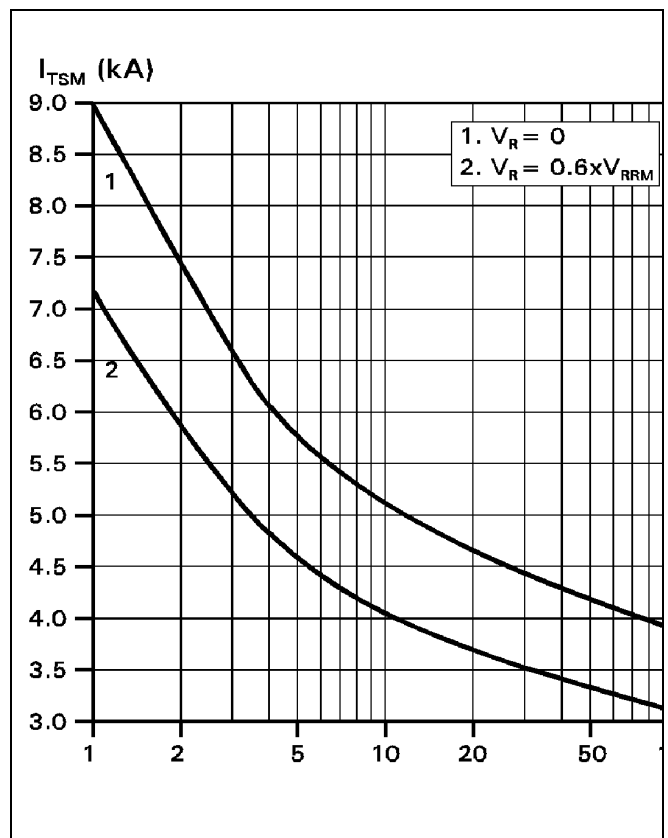

Fig. 7 Surge on-state current vs. number of pulses. Half-sine wave, 10 ms, 50Hz.

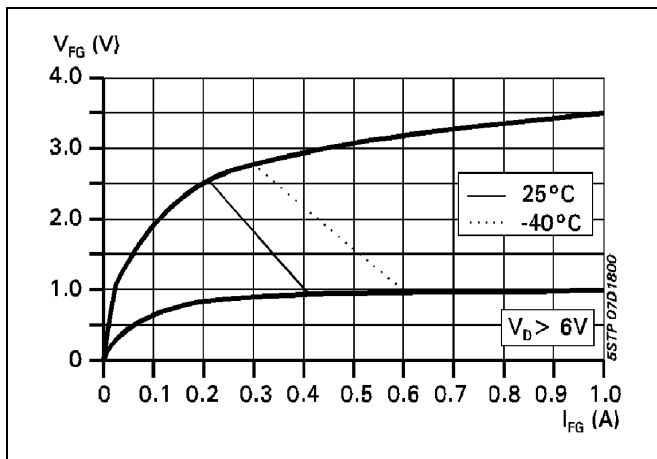

Fig. 8 Gate trigger characteristics.

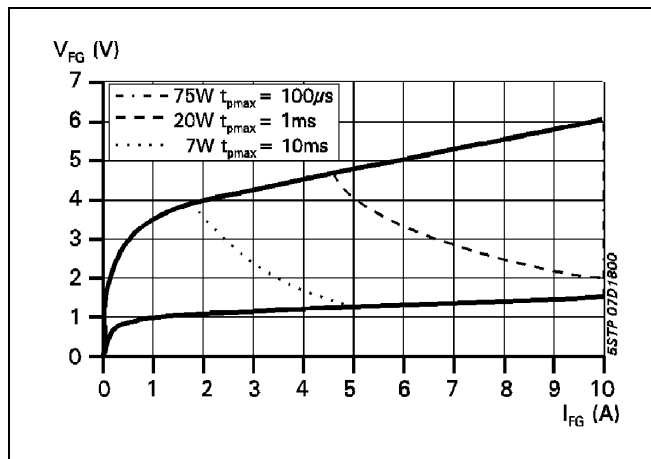

Fig. 9 Max. peak gate power loss.

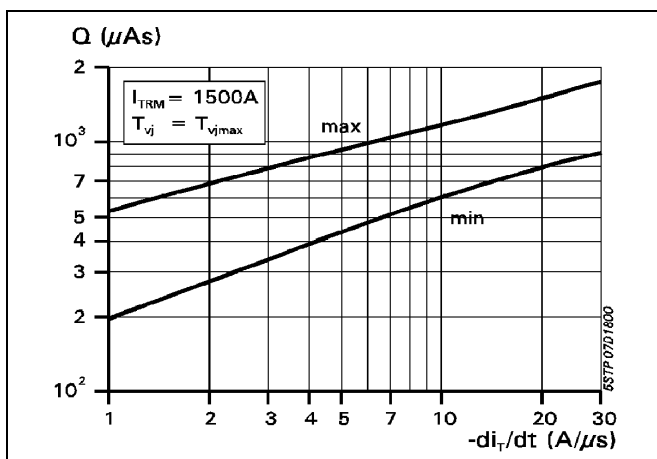

Fig. 10 Recovery charge vs. decay rate of on-state current.

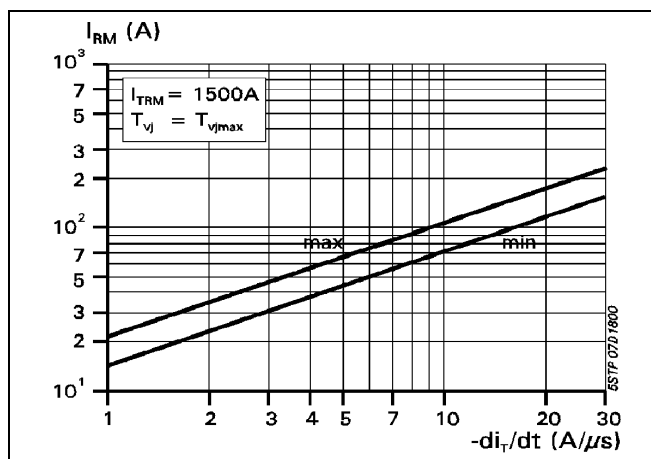

Fig. 11 Peak reverse recovery current vs. decay rate of on-state current.

ABB Semiconductors AG reserves the right to change specifications without notice.



ABB Semiconductors AG
 Fabrikstrasse 3
 CH-5600 Lenzburg, Switzerland

Telephone +41 (0)62 888 6419
 Fax +41 (0)62 888 6306
 Email abbsem@ch.abb.com
 Internet www.abbsem.com