

V_{SM}	=	5200 V
$I_{T(AV)M}$	=	1980 A
$I_{T(RMS)}$	=	3100 A
I_{TSM}	=	42×10 A
V_{T0}	=	1.06 V
r_T	=	0.219 mΩ

Bi-Directional Control Thyristor

5STB 25U5200

Preliminary

Doc. No. 5SYA1038-02 Jul. 03

- Two thyristors integrated into one wafer
- Patented free-floating silicon technology
- Designed for energy and industrial applications
- Optimum power handling capability
- Interdigitated amplifying gate.

The electrical and thermal data are valid for one thyristor half of the device.

Blocking

Maximum rated values ¹⁾

Symbol	Conditions	5STB 25U5200	5STB 25U5000	5STB 25U4600
V_{SM}	f = 5 Hz, t _p = 10 ms	5200 V	5000 V	4600 V
V_{RM}	f = 50 Hz, t _p = 10 ms	4400 V	4200 V	4000 V
dV/dt _{crit}	Exp. to 0.67 × V _{RM} , T _{vj} = 110°C	2000 V/μs		

Characteristic values

Parameter	Symbol	Conditions	min	typ	max	Unit
Max. leakage current	I _{RM}	V _{RM} , T _{vj} = 110°C			400	mA

V_{RM} is equal to the V_{SM} value up to T_j = 95 °C

Mechanical data

Maximum rated values ¹⁾

Parameter	Symbol	Conditions	min	typ	max	Unit
Mounting force	F _M		120	135	160	kN
Acceleration	a	Device unclamped			50	m/s ²
Acceleration	a	Device clamped			100	m/s ²

Characteristic values

Parameter	Symbol	Conditions	min	typ	max	Unit
Weight	m				3.6	kg
Surface creepage distance	D _S		53			mm
Air strike distance	D _a		22			mm

1) Maximum rated values indicate limits beyond which damage to the device may occur

ABB Switzerland Ltd, Semiconductors reserves the right to change specifications without notice.



On-state

Maximum rated values ¹⁾

Parameter	Symbol	Conditions	min	typ	max	Unit
Average on-state current	$I_{T(AV)M}$	Half sine wave, $T_c = 70^\circ\text{C}$			1980	A
RMS on-state current	$I_{T(RMS)}$				3100	A
Peak non-repetitive surge current	I_{TSM}	$t_p = 10\text{ ms}$, $T_{vj} = 110^\circ\text{C}$, $V_D = V_R = 0\text{ V}$			42.0×10^3	A
Limiting load integral	I^2t				8.82×10^6	A^2s
Peak non-repetitive surge current	I_{TSM}	$t_p = 8.3\text{ ms}$, $T_{vj} = 110^\circ\text{C}$, $V_D = V_R = 0\text{ V}$			45.0×10^3	A
Limiting load integral	I^2t				8.40×10^6	A^2s

Characteristic values

Parameter	Symbol	Conditions	min	typ	max	Unit
On-state voltage	V_T	$I_T = 3000\text{ A}$, $T_{vj} = 110^\circ\text{C}$			1.7	V
Threshold voltage	V_{T0}	$I_T = 1300\text{ A} - 4000\text{ A}$, $T_{vj} = 110^\circ\text{C}$			1.06	V
Slope resistance	r_T				0.219	$\text{m}\Omega$
Holding current	I_H	$T_{vj} = 25^\circ\text{C}$			125	mA
		$T_{vj} = 110^\circ\text{C}$			70	mA
Latching current	I_L	$T_{vj} = 25^\circ\text{C}$			900	mA
		$T_{vj} = 110^\circ\text{C}$			700	mA

Switching

Maximum rated values ¹⁾

Parameter	Symbol	Conditions	min	typ	max	Unit
Critical rate of rise of on-state current	di/dt_{crit}	$T_{vj} = 110^\circ\text{C}$, $I_{TRM} = 3000\text{ A}$, Cont. $f = 50\text{ Hz}$			250	$\text{A}/\mu\text{s}$
Critical rate of rise of on-state current	di/dt_{crit}	$V_D \leq 0.67 V_{RM}$, $I_{FG} = \text{A}$, $t_r = 0.5\ \mu\text{s}$ Cont. $f = 1\text{ Hz}$			1000	$\text{A}/\mu\text{s}$
Circuit commutated turn-off time	t_q	$T_{vj} = 110^\circ\text{C}$, $I_{TRM} = 2000\text{ A}$, $V_R = 200\text{ V}$, $di_T/dt = -1.5\ \text{A}/\mu\text{s}$, $V_D \leq 0.67 \cdot V_{RM}$, $dv_D/dt = 20\text{ V}/\mu\text{s}$,	800			μs

Characteristic values

Parameter	Symbol	Conditions	min	typ	max	Unit
Recovery charge	Q_{rr}	$T_{vj} = 110^\circ\text{C}$, $I_{TRM} = 2000\text{ A}$, $V_R = 200\text{ V}$, $di_T/dt = -1.5\ \text{A}/\mu\text{s}$	3600		4600	μAs
Delay time	t_d	$V_D = 0.4 \cdot V_{RM}$, $I_{FG} = 2\text{ A}$, $t_r = 0.5\ \mu\text{s}$			3	μs

Triggering

Maximum rated values ¹⁾

Parameter	Symbol	Conditions	min	typ	max	Unit
Peak forward gate voltage	V _{FGM}				12	V
Max. rated peak forward gate current	I _{FGM}				10	A
Peak reverse gate voltage	V _{RGM}				10	V
Max. rated gate power loss	P _G	For DC gate current			3	W
Max. rated peak forward gate power	P _{GM}		see Fig. 9			

Characteristic values

Parameter	Symbol	Conditions	min	typ	max	Unit
Gate trigger voltage	V _{GT}	T _{vj} = 25 °C			2.6	V
Gate trigger current	I _{GT}	T _{vj} = 25 °C			400	mA
Gate non-trigger voltage	V _{GD}	V _D = 0.4 x V _{RM} , T _{vjmax} = 110 °C	0.3			V
Gate non-trigger current	I _{GD}	V _D = 0.4 x V _{RM}	10			mA

Thermal

Maximum rated values ¹⁾

Parameter	Symbol	Conditions	min	typ	max	Unit
Operating junction temperature range	T _{vj}				110	°C
Storage temperature range	T _{stg}		-40		140	°C

Characteristic values

Parameter	Symbol	Conditions	min	typ	max	Unit
Thermal resistance junction to case	R _{th(j-c)}	Double-side cooled			8.5	K/kW
	R _{th(j-c)A}	Anode-side cooled			17	K/kW
	R _{th(j-c)C}	Cathode-side cooled			17	K/kW
Thermal resistance case to heatsink	R _{th(c-h)}	Double-side cooled			1.6	K/kW
	R _{th(c-h)}	Single-side cooled			3.2	K/kW

Analytical function for transient thermal impedance:

$$Z_{th(j-c)}(t) = \sum_{i=1}^n R_i(1 - e^{-t/\tau_i})$$

i	1	2	3	4
R _i (K/kW)	5.748	1.731	0.688	0.333
τ _i (s)	0.9531	0.1240	0.0144	0.0031

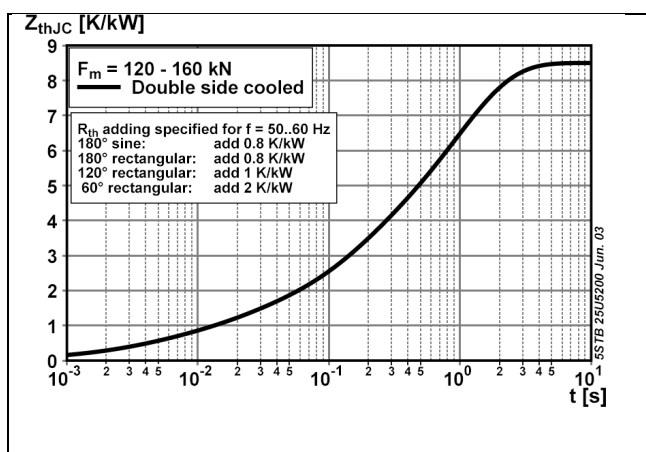

Fig. 1 Transient thermal impedance junction-to case.

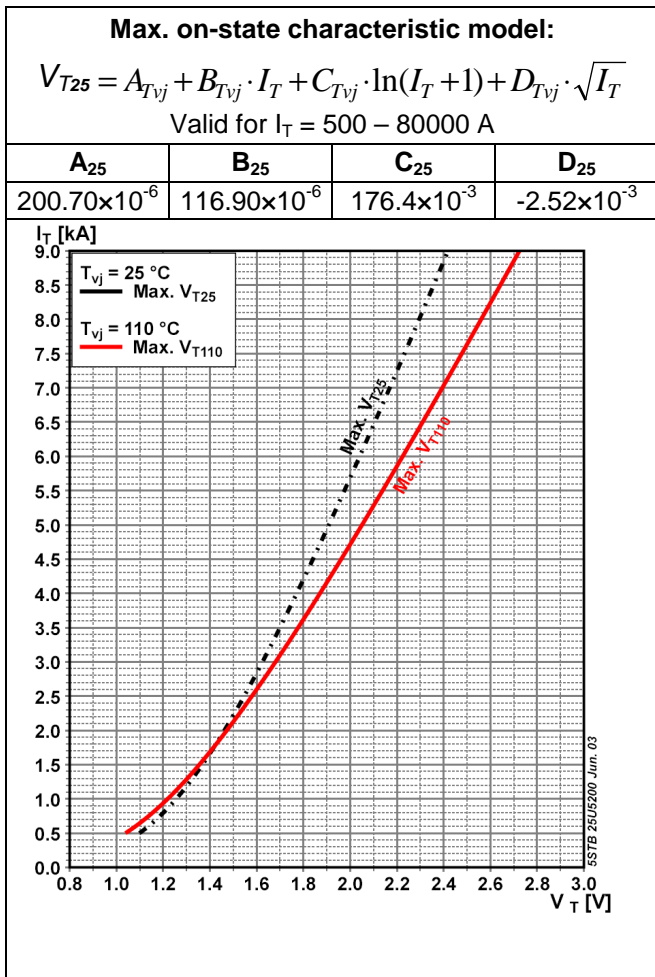

Fig. 2 Max. on-state voltage characteristics

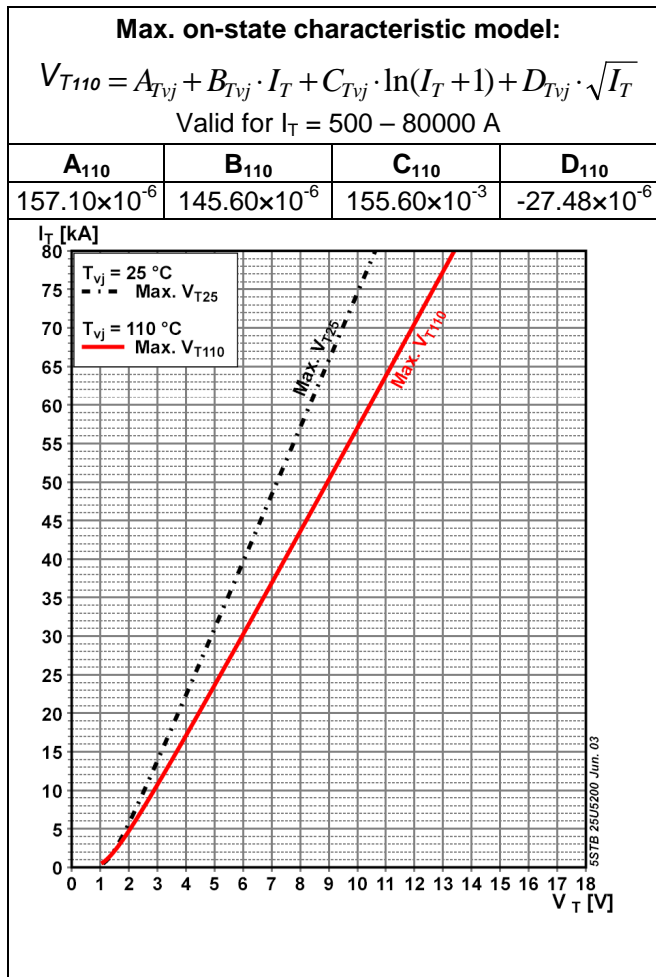

Fig. 3 Max. on-state voltage characteristics

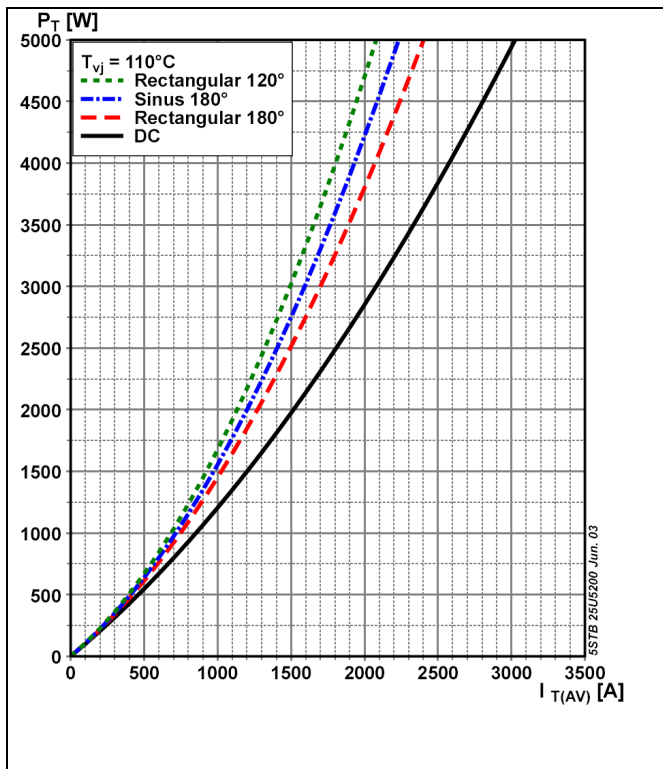

Fig. 4 On-state power dissipation vs. mean on-state current. Turn - on losses excluded.

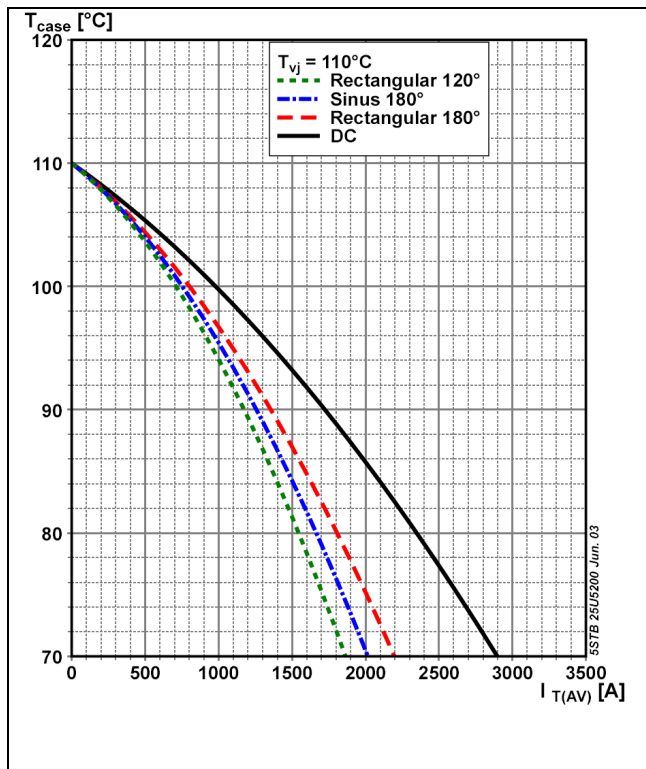

Fig. 5 Max. permissible case temperature vs. mean on-state current.

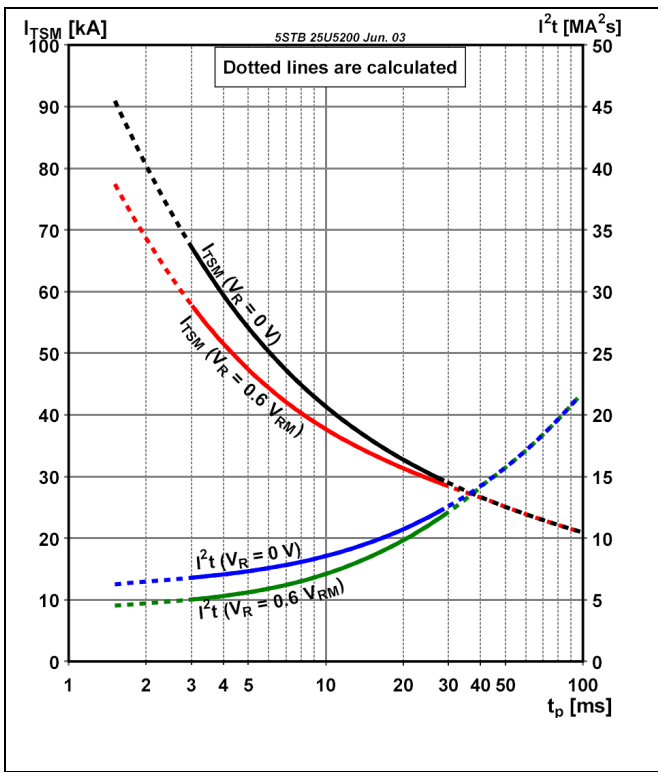

Fig. 6 Surge on-state current vs. pulse length. Half-sine wave.

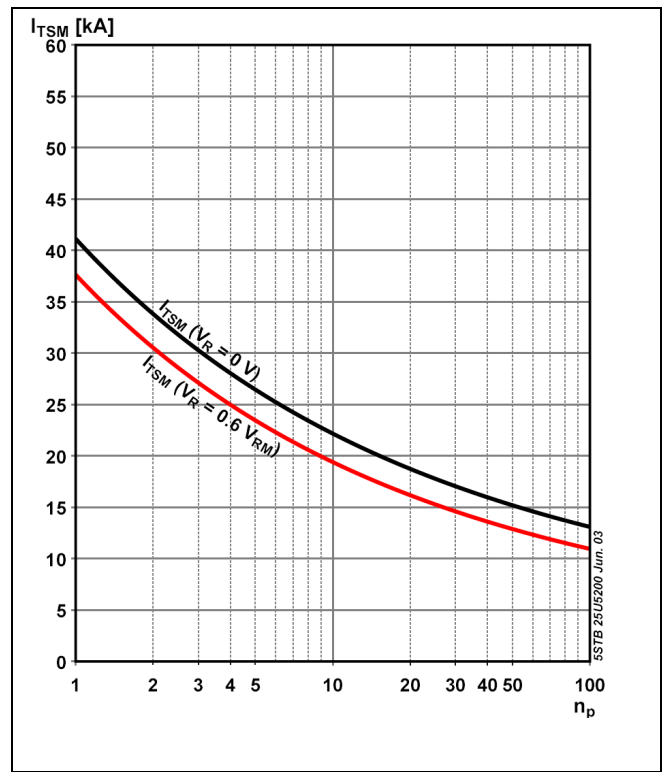

Fig. 7 Surge on-state current vs. number of pulses. Half-sine wave, 10 ms, 50Hz.

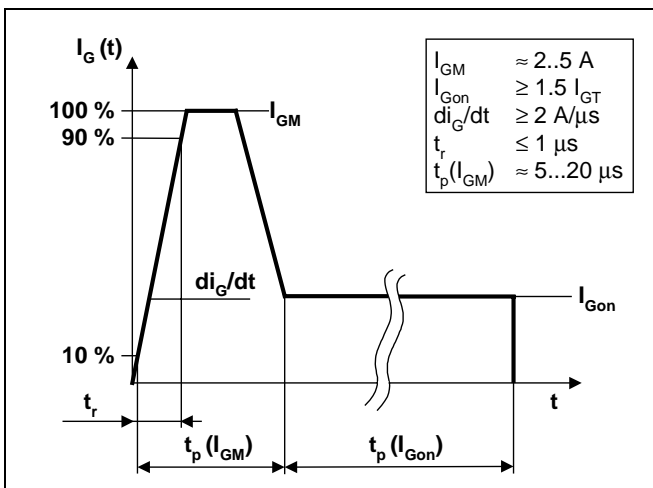

Fig. 8 Recommended gate current waveform.

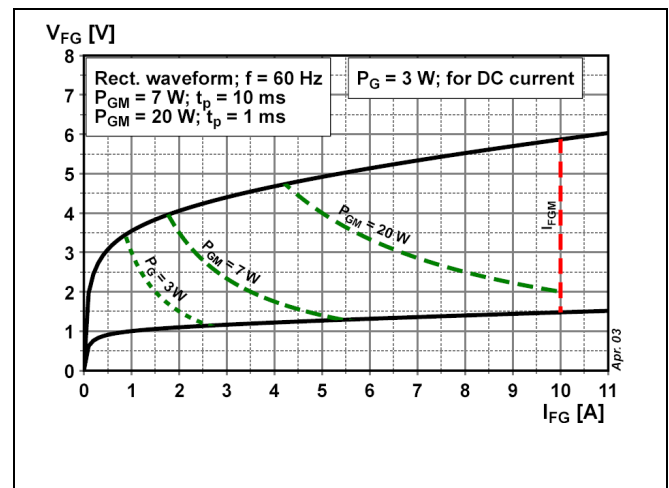

Fig. 9 Max. peak gate power loss.

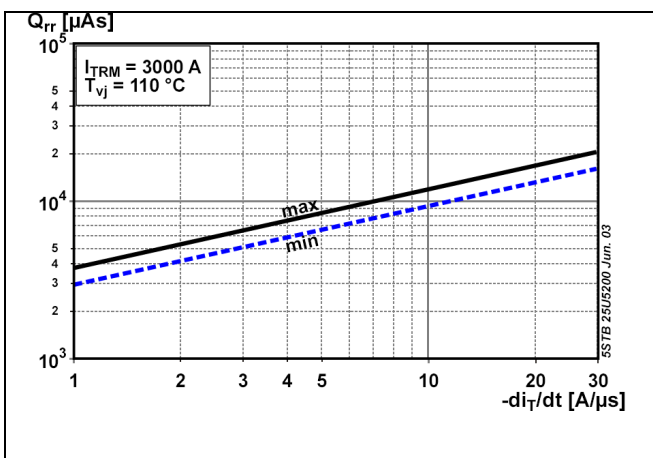

Fig. 10 Recovery charge vs. decay rate of on-state current.

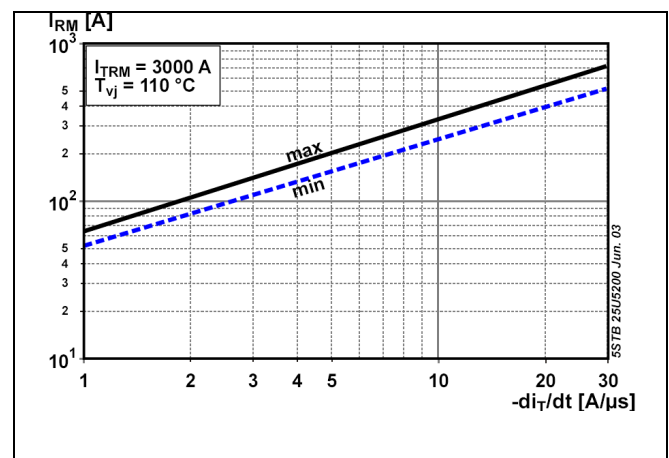

Fig. 11 Peak reverse recovery current vs. decay rate of on-state current.

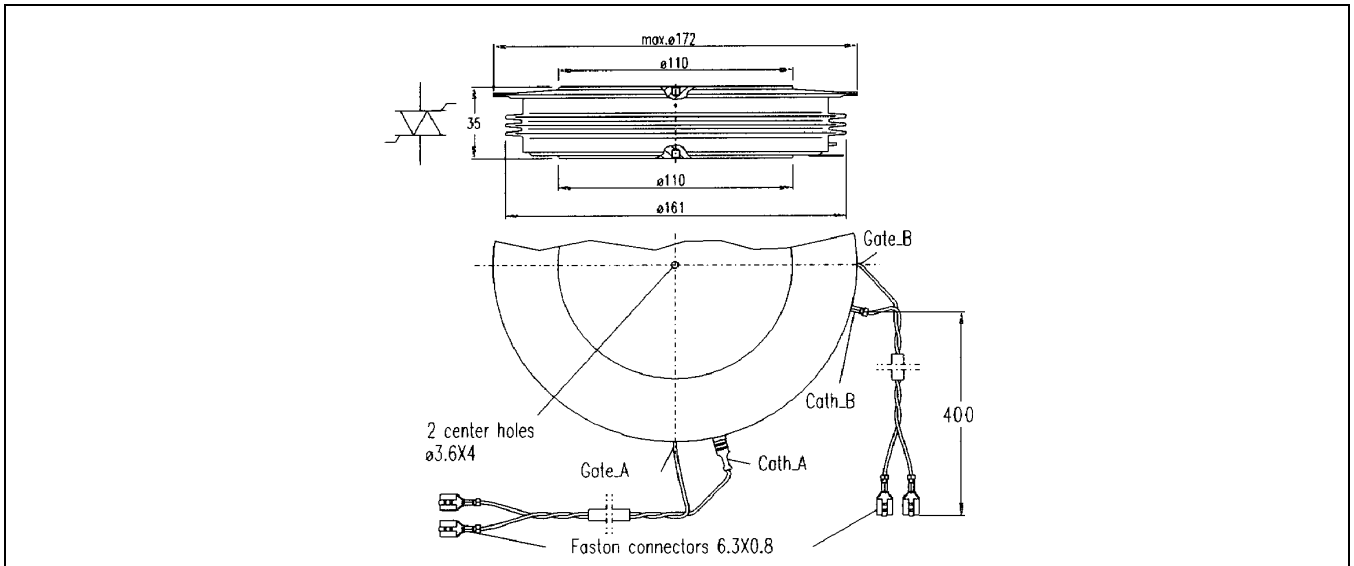

Fig. 12 Device Outline Drawing.

ABB Switzerland Ltd, Semiconductors reserves the right to change specifications without notice.

ABB

ABB Switzerland Ltd
Semiconductors
 Fabrikstrasse 3
 CH-5600 Lenzburg, Switzerland

Doc. No. 5SYA1038-02 Jul. 03

Telephone +41 (0)58 586 1419
 Fax +41 (0)58 586 1306
 Email abbsem@ch.abb.com
 Internet www.abb.com/semiconductors

This datasheet has been downloaded from:

www.EEworld.com.cn

Free Download

Daily Updated Database

100% Free Datasheet Search Site

100% Free IC Replacement Search Site

Convenient Electronic Dictionary

Fast Search System

www.EEworld.com.cn