

SKiiP 24ACC12T4V10

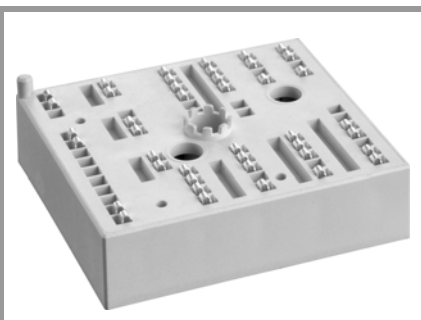

MiniSKiiP® 2

Twin 6-pack

SKiiP 24ACC12T4V10

Features

- Trench 4 IGBTs
- Robust and soft freewheeling diodes in CAL technology
- Highly reliable spring contacts for electrical connections
- UL recognised: File no. E63532

Typical Applications*

- 4Q inverters

Remarks

- Max. case temperature limited to $T_C=125^\circ\text{C}$
- Product reliability results valid for $T_j \leq 150^\circ\text{C}$ (recommended $T_{j,op} = -40 \dots +150^\circ\text{C}$)
- Terminal distances sufficient for basic insulation in 3-phase 480VAC TN systems
- DC-link voltage $V_{DC} \leq 800\text{V}$
- Temperature sensor: no basic insulation to main circuit, signal processing with reference to -DC potential
- Please refer to MiniSKiiP "Technical Explanations" and "Mounting Instructions" for further information

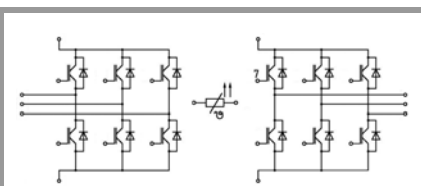

ACC

Absolute Maximum Ratings

Symbol	Conditions	Values	Unit	
IGBT 1 - 6				
V_{CES}	$T_j = 25^\circ\text{C}$	1200	V	
I_C	$\lambda_{paste}=0.8\text{ W/(mK)}$	$T_s = 25^\circ\text{C}$	41	A
	$T_j = 175^\circ\text{C}$	$T_s = 70^\circ\text{C}$	34	A
I_C	$\lambda_{paste}=2.5\text{ W/(mK)}$	$T_s = 25^\circ\text{C}$	45	A
	$T_j = 175^\circ\text{C}$	$T_s = 70^\circ\text{C}$	37	A
I_{Cnom}		25	A	
I_{CRM}	$I_{CRM} = 3 \times I_{Cnom}$	75	A	
V_{GES}		-20 ... 20	V	
t_{psc}	$V_{CC} = 800\text{ V}$ $V_{GE} \leq 15\text{ V}$ $V_{CES} \leq 1200\text{ V}$	$T_j = 150^\circ\text{C}$	10	μs
T_j		-40 ... 175	$^\circ\text{C}$	
IGBT 7 - 12				
V_{CES}	$T_j = 25^\circ\text{C}$	1200	V	
I_C	$\lambda_{paste}=0.8\text{ W/(mK)}$	$T_s = 25^\circ\text{C}$	52	A
	$T_j = 175^\circ\text{C}$	$T_s = 70^\circ\text{C}$	43	A
I_C	$\lambda_{paste}=2.5\text{ W/(mK)}$	$T_s = 25^\circ\text{C}$	58	A
	$T_j = 175^\circ\text{C}$	$T_s = 70^\circ\text{C}$	48	A
I_{Cnom}		35	A	
I_{CRM}	$I_{CRM} = 3 \times I_{Cnom}$	105	A	
V_{GES}		-20 ... 20	V	
t_{psc}	$V_{CC} = 800\text{ V}$ $V_{GE} \leq 15\text{ V}$ $V_{CES} \leq 1200\text{ V}$	$T_j = 150^\circ\text{C}$	10	μs
T_j		-40 ... 175	$^\circ\text{C}$	
Diode 1 - 6				
V_{RRM}	$T_j = 25^\circ\text{C}$	1200	V	
I_F	$\lambda_{paste}=0.8\text{ W/(mK)}$	$T_s = 25^\circ\text{C}$	32	A
	$T_j = 175^\circ\text{C}$	$T_s = 70^\circ\text{C}$	26	A
I_F	$\lambda_{paste}=2.5\text{ W/(mK)}$	$T_s = 25^\circ\text{C}$	35	A
	$T_j = 175^\circ\text{C}$	$T_s = 70^\circ\text{C}$	28	A
I_{Fnom}		25	A	
I_{FRM}	$I_{FRM} = 3 \times I_{Fnom}$	75	A	
I_{FSM}	10 ms, sin 180°, $T_j = 150^\circ\text{C}$	100	A	
T_j		-40 ... 175	$^\circ\text{C}$	
Diode 7 - 12				
V_{RRM}	$T_j = 25^\circ\text{C}$	1200	V	
I_F	$\lambda_{paste}=0.8\text{ W/(mK)}$	$T_s = 25^\circ\text{C}$	44	A
	$T_j = 175^\circ\text{C}$	$T_s = 70^\circ\text{C}$	35	A
I_F	$\lambda_{paste}=2.5\text{ W/(mK)}$	$T_s = 25^\circ\text{C}$	49	A
	$T_j = 175^\circ\text{C}$	$T_s = 70^\circ\text{C}$	40	A
I_{Fnom}		35	A	
I_{FRM}	$I_{FRM} = 3 \times I_{Fnom}$	105	A	
I_{FSM}	10 ms, sin 180°, $T_j = 150^\circ\text{C}$	170	A	
T_j		-40 ... 175	$^\circ\text{C}$	
Module				
$I_{t(RMS)}$	20 A per spring	40	A	
T_{stg}		-40 ... 125	$^\circ\text{C}$	
V_{isol}	AC sinus 50 Hz, 1 min	2500	V	

SKiiP 24ACC12T4V10

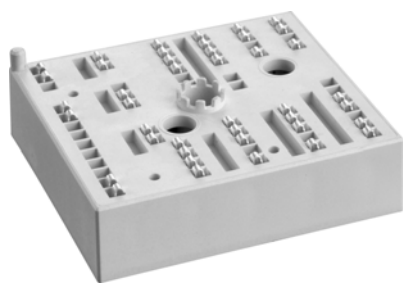

MiniSKiiP® 2

Twin 6-pack

SKiiP 24ACC12T4V10

Features

- Trench 4 IGBTs
- Robust and soft freewheeling diodes in CAL technology
- Highly reliable spring contacts for electrical connections
- UL recognised: File no. E63532

Typical Applications*

- 4Q inverters

Remarks

- Max. case temperature limited to $T_C=125^\circ\text{C}$
- Product reliability results valid for $T_j \leq 150^\circ\text{C}$ (recommended $T_{j,op} = -40 \dots +150^\circ\text{C}$)
- Terminal distances sufficient for basic insulation in 3-phase 480VAC TN systems
- DC-link voltage $V_{DC} \leq 800\text{V}$
- Temperature sensor: no basic insulation to main circuit, signal processing with reference to -DC potential
- Please refer to MiniSKiiP "Technical Explanations" and "Mounting Instructions" for further information

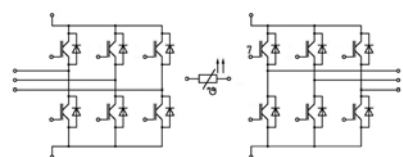

ACC

Characteristics						
Symbol	Conditions		min.	typ.	max.	Unit
IGBT 1 - 6						
$V_{CE(sat)}$	$I_C = 25\text{ A}$ $V_{GE} = 15\text{ V}$ chipllevel	$T_j = 25^\circ\text{C}$	1.85	2.10		V
		$T_j = 150^\circ\text{C}$	2.25	2.45		V
V_{CE0}	chipllevel	$T_j = 25^\circ\text{C}$	0.80	0.90		V
		$T_j = 150^\circ\text{C}$	0.70	0.80		V
r_{CE}	$V_{GE} = 15\text{ V}$ chipllevel	$T_j = 25^\circ\text{C}$	42	48		m Ω
		$T_j = 150^\circ\text{C}$	62	66		m Ω
$V_{GE(th)}$	$V_{GE} = V_{CE}\text{ V}, I_C = 1\text{ mA}$		5	5.8	6.5	V
I_{CES}	$V_{GE} = 0\text{ V}$ $V_{CE} = 1200\text{ V}$	$T_j = 25^\circ\text{C}$	0.1	0.3		mA
						mA
C_{ies}	$V_{CE} = 25\text{ V}$	$f = 1\text{ MHz}$		1.43		nF
C_{oes}	$V_{GE} = 0\text{ V}$	$f = 1\text{ MHz}$		0.12		nF
C_{res}		$f = 1\text{ MHz}$		0.09		nF
Q_G	$V_{GE} = -8\text{ V} \dots +15\text{ V}$			142		nC
R_{Gint}	$T_j = 25^\circ\text{C}$			0.0		Ω
$t_{d(on)}$	$V_{CC} = 600\text{ V}$	$T_j = 150^\circ\text{C}$		96		ns
t_r	$I_C = 25\text{ A}$	$T_j = 150^\circ\text{C}$		80		ns
E_{on}	$R_{G\ on} = 39\ \Omega$ $R_{G\ off} = 39\ \Omega$	$T_j = 150^\circ\text{C}$		4.2		mJ
$t_{d(off)}$	$di/dt_{on} = 250\text{ A}/\mu\text{s}$	$T_j = 150^\circ\text{C}$		400		ns
t_f	$di/dt_{off} = 400\text{ A}/\mu\text{s}$ $du/dt = 3600\text{ V}/\mu\text{s}$	$T_j = 150^\circ\text{C}$		51		ns
E_{off}	$V_{GE} = +15/-15\text{ V}$ $L_s = 22\text{ nH}$	$T_j = 150^\circ\text{C}$		2.6		mJ
$R_{th(j-s)}$	per IGBT, $\lambda_{paste}=0.8\text{ W}/(\text{mK})$			1		K/W
$R_{th(j-s)}$	per IGBT, $\lambda_{paste}=2.5\text{ W}/(\text{mK})$			0.84		K/W
IGBT 7 - 12						
$V_{CE(sat)}$	$I_C = 35\text{ A}$ $V_{GE} = 15\text{ V}$ chipllevel	$T_j = 25^\circ\text{C}$	1.85	2.10		V
		$T_j = 150^\circ\text{C}$	2.25	2.45		V
V_{CE0}	chipllevel	$T_j = 25^\circ\text{C}$	0.80	0.90		V
		$T_j = 150^\circ\text{C}$	0.70	0.80		V
r_{CE}	$V_{GE} = 15\text{ V}$ chipllevel	$T_j = 25^\circ\text{C}$	30	34		m Ω
		$T_j = 150^\circ\text{C}$	44	47		m Ω
$V_{GE(th)}$	$V_{GE} = V_{CE}\text{ V}, I_C = 1\text{ mA}$		5	5.8	6.5	V
I_{CES}	$V_{GE} = 0\text{ V}$ $V_{CE} = 1200\text{ V}$	$T_j = 25^\circ\text{C}$	0.1	0.3		mA
			-			mA
C_{ies}	$V_{CE} = 25\text{ V}$	$f = 1\text{ MHz}$		1.95		nF
C_{oes}	$V_{GE} = 0\text{ V}$	$f = 1\text{ MHz}$		0.16		nF
C_{res}		$f = 1\text{ MHz}$		0.12		nF
Q_G	$V_{GE} = -8\text{ V} \dots +15\text{ V}$			200		nC
R_{Gint}	$T_j = 25^\circ\text{C}$			0		Ω
$t_{d(on)}$	$V_{CC} = 600\text{ V}$	$T_j = 150^\circ\text{C}$		52		ns
t_r	$I_C = 35\text{ A}$	$T_j = 150^\circ\text{C}$		34		ns
E_{on}	$R_{G\ on} = 16\ \Omega$ $R_{G\ off} = 16\ \Omega$	$T_j = 150^\circ\text{C}$		3.9		mJ
$t_{d(off)}$	$di/dt_{on} = 680\text{ A}/\mu\text{s}$	$T_j = 150^\circ\text{C}$		337		ns
t_f	$di/dt_{off} = 560\text{ A}/\mu\text{s}$ $du/dt = 4000\text{ V}/\mu\text{s}$	$T_j = 150^\circ\text{C}$		53		ns
E_{off}	$V_{GE} = +15/-15\text{ V}$ $L_s = 22\text{ nH}$	$T_j = 150^\circ\text{C}$		3.5		mJ
$R_{th(j-s)}$	per IGBT, $\lambda_{paste}=0.8\text{ W}/(\text{mK})$			0.85		K/W
$R_{th(j-s)}$	per IGBT, $\lambda_{paste}=2.5\text{ W}/(\text{mK})$			0.7		K/W

SKiiP 24ACC12T4V10

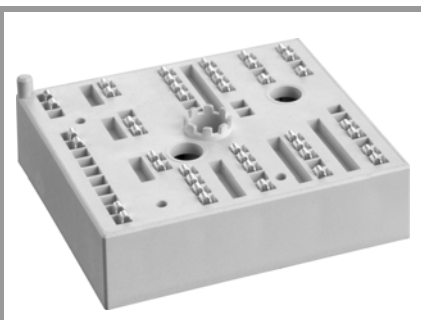

MiniSKiiP® 2

Twin 6-pack

SKiiP 24ACC12T4V10

Features

- Trench 4 IGBTs
- Robust and soft freewheeling diodes in CAL technology
- Highly reliable spring contacts for electrical connections
- UL recognised: File no. E63532

Typical Applications*

- 4Q inverters

Remarks

- Max. case temperature limited to $T_C=125^{\circ}\text{C}$
- Product reliability results valid for $T_j \leq 150^{\circ}\text{C}$ (recommended $T_{j,op} = -40 \dots +150^{\circ}\text{C}$)
- Terminal distances sufficient for basic insulation in 3-phase 480VAC TN systems
- DC-link voltage $V_{DC} \leq 800\text{V}$
- Temperature sensor: no basic insulation to main circuit, signal processing with reference to -DC potential
- Please refer to MiniSKiiP "Technical Explanations" and "Mounting Instructions" for further information

Characteristics			min.	typ.	max.	Unit
Symbol	Conditions					
Diode 1 - 6						
$V_F = V_{EC}$	$I_F = 25\text{ A}$ $V_{GE} = 0\text{ V}$ chipelevel	$T_j = 25^{\circ}\text{C}$		2.41	2.74	V
		$T_j = 150^{\circ}\text{C}$		2.45	2.79	V
V_{F0}	chipelevel	$T_j = 25^{\circ}\text{C}$		1.30	1.50	V
		$T_j = 150^{\circ}\text{C}$		0.90	1.10	V
r_F	chipelevel	$T_j = 25^{\circ}\text{C}$		44	50	m Ω
		$T_j = 150^{\circ}\text{C}$		62	68	m Ω
I_{RRM}	$I_F = 25\text{ A}$	$T_j = 150^{\circ}\text{C}$		17		A
Q_{rr}	$di/dt_{off} = 380\text{ A}/\mu\text{s}$ $V_{GE} = -15\text{ V}$	$T_j = 150^{\circ}\text{C}$		4		μC
E_{rr}	$V_{CC} = 600\text{ V}$	$T_j = 150^{\circ}\text{C}$		1.4		mJ
$R_{th(j-s)}$	per Diode, $\lambda_{paste}=0.8\text{ W}/(\text{mK})$			1.52		K/W
$R_{th(j-s)}$	per Diode, $\lambda_{paste}=2.5\text{ W}/(\text{mK})$			1.31		K/W
Diode 7 - 12						
$V_F = V_{EC}$	$I_F = 35\text{ A}$ $V_{GE} = 0\text{ V}$ chipelevel	$T_j = 25^{\circ}\text{C}$		2.30	2.62	V
		$T_j = 150^{\circ}\text{C}$		2.29	2.62	V
V_{F0}	chipelevel	$T_j = 25^{\circ}\text{C}$		1.30	1.50	V
		$T_j = 150^{\circ}\text{C}$		0.90	1.10	V
r_F	chipelevel	$T_j = 25^{\circ}\text{C}$		29	32	m Ω
		$T_j = 150^{\circ}\text{C}$		40	43	m Ω
I_{RRM}	$I_F = 35\text{ A}$	$T_j = 150^{\circ}\text{C}$		28		A
Q_{rr}	$di/dt_{off} = 720\text{ A}/\mu\text{s}$ $V_{GE} = -15\text{ V}$	$T_j = 150^{\circ}\text{C}$		5.8		μC
E_{rr}	$V_{CC} = 600\text{ V}$	$T_j = 150^{\circ}\text{C}$		2.3		mJ
$R_{th(j-s)}$	per Diode, $\lambda_{paste}=0.8\text{ W}/(\text{mK})$			1.2		K/W
$R_{th(j-s)}$	per Diode, $\lambda_{paste}=2.5\text{ W}/(\text{mK})$			1		K/W
Module						
L_{CE}				30		nH
M_s	to heat sink		2		2.5	Nm
w				55		g
Temperature Sensor						
R_{100}	$T_r=100^{\circ}\text{C}$ ($R_{25}=1000\Omega$)			$1670 \pm 3\%$		Ω
$R(T)$	$R(T)=1000\Omega[1+A(T-25^{\circ}\text{C})+B(T-25^{\circ}\text{C})^2]$ $A = 7.635 \cdot 10^{-3} \text{ }^{\circ}\text{C}^{-1}$, $B = 1.731 \cdot 10^{-5} \text{ }^{\circ}\text{C}^{-2}$					

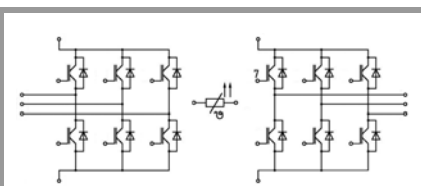

ACC

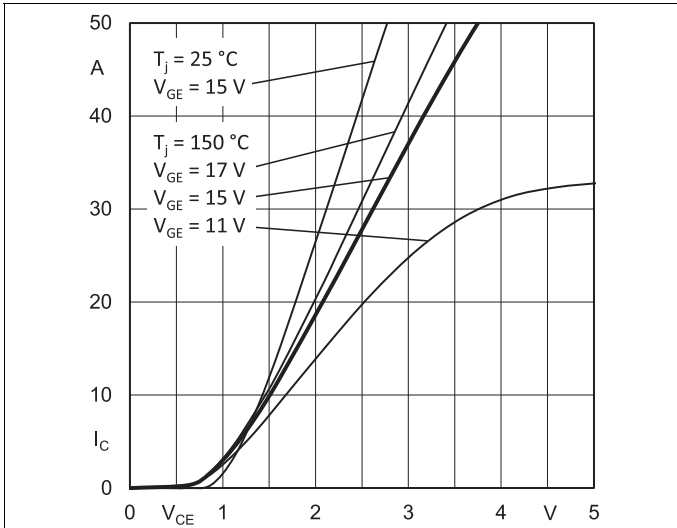

IGBT 1-6 - Fig. 1:
Typ. output characteristic

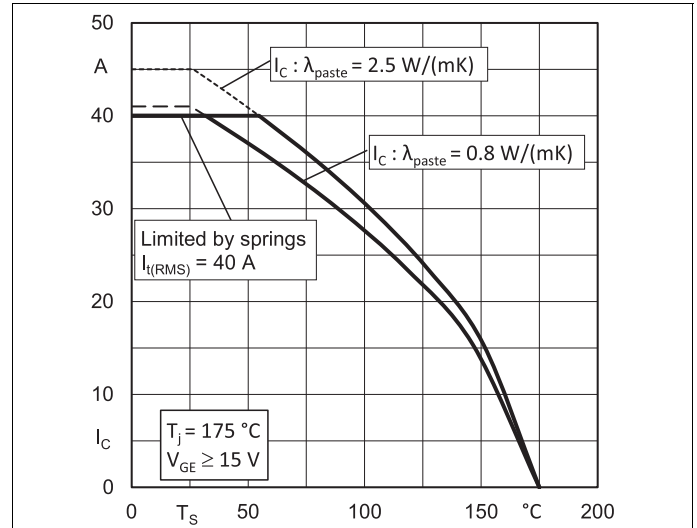

IGBT 1-6 - Fig. 2:
Typ. rated current vs. temperature $I_C = f(T_S)$

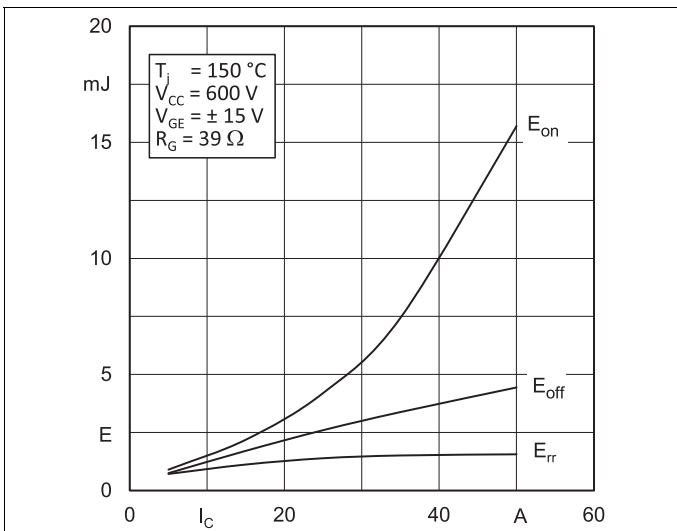

IGBT 1-6 - Fig. 3:
Typ. turn-on /-off energy = $f(I_C)$

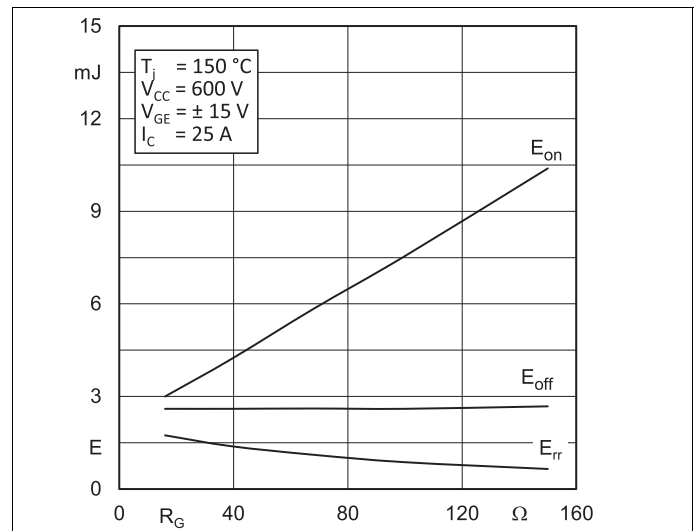

IGBT 1-6 - Fig. 4:
Typ. turn-on /-off energy = $f(R_G)$

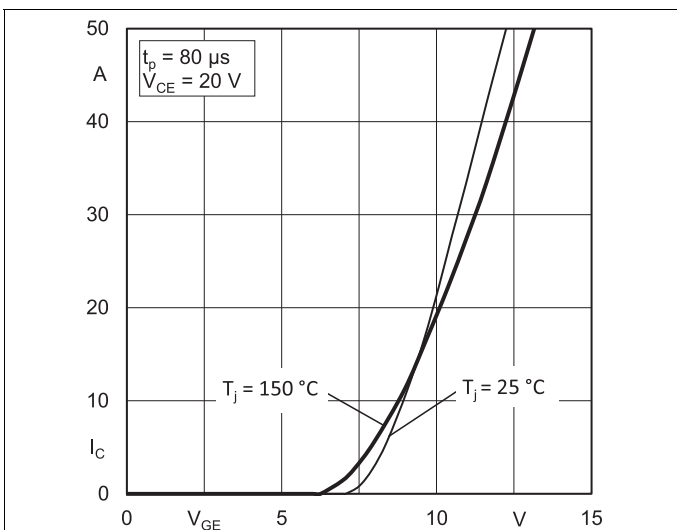

IGBT 1-6 - Fig. 5:
Typ. transfer characteristic

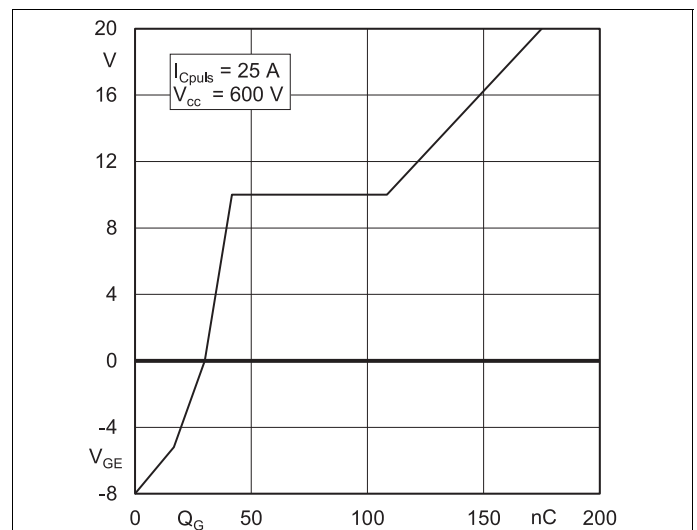

IGBT 1-6 - Fig. 6:
Typ. gate charge characteristic

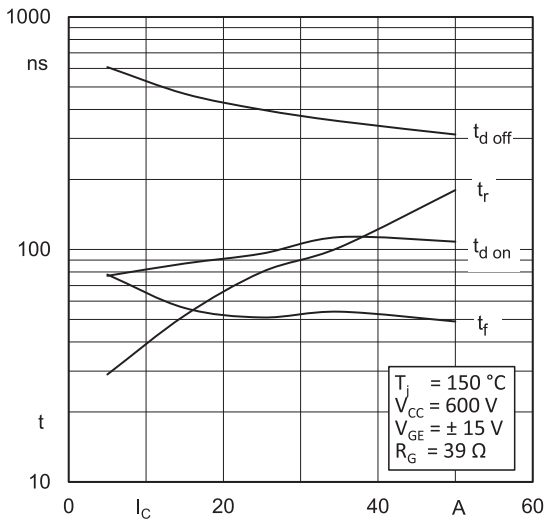

IGBT 1-6 - Fig. 7:
Typ. switching times vs. I_C

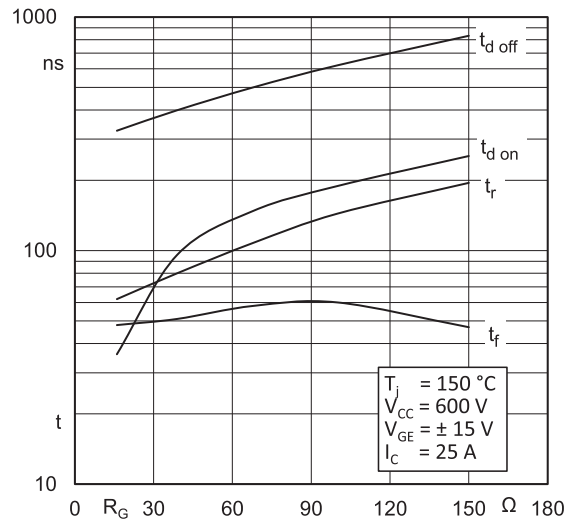

IGBT 1-6 - Fig. 8:
Typ. switching times vs. gate resistor R_G

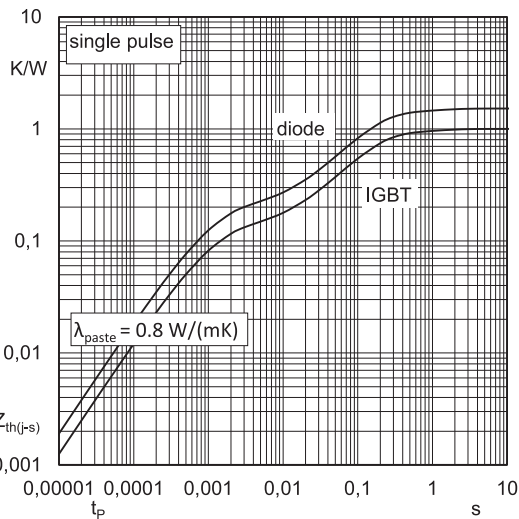

IGBT 1-6 - Fig. 9:
Transient thermal impedance of IGBT and Diode

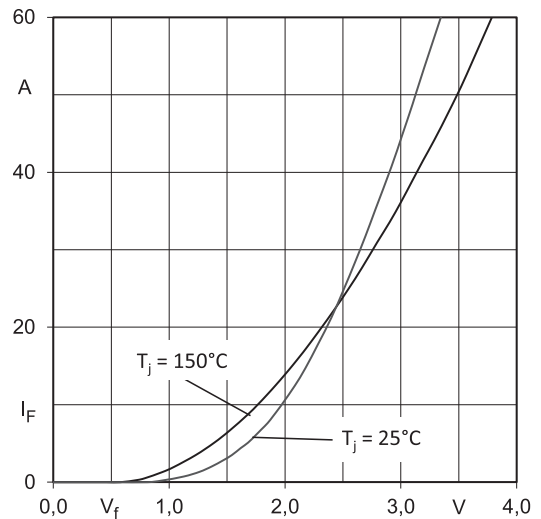

IGBT 1-6 - Fig. 10:
CAL diode forward characteristic

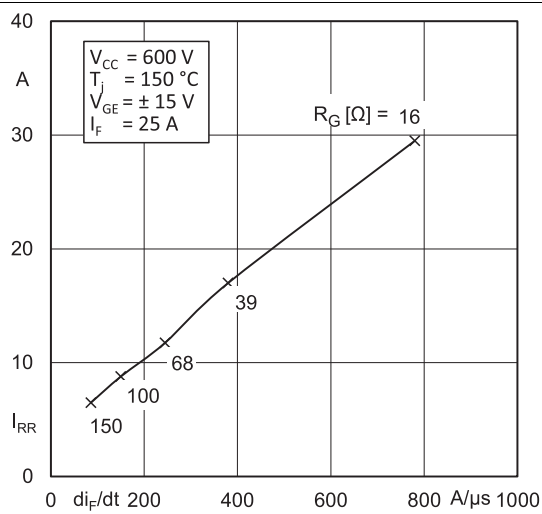

IGBT 1-6 - Fig. 11:
Typ. CAL diode peak reverse recovery current

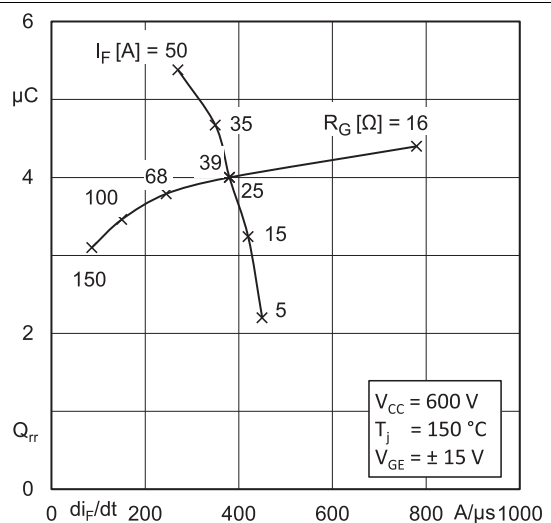

IGBT 1-6 - Fig. 12:
Typ. CAL diode recovery charge

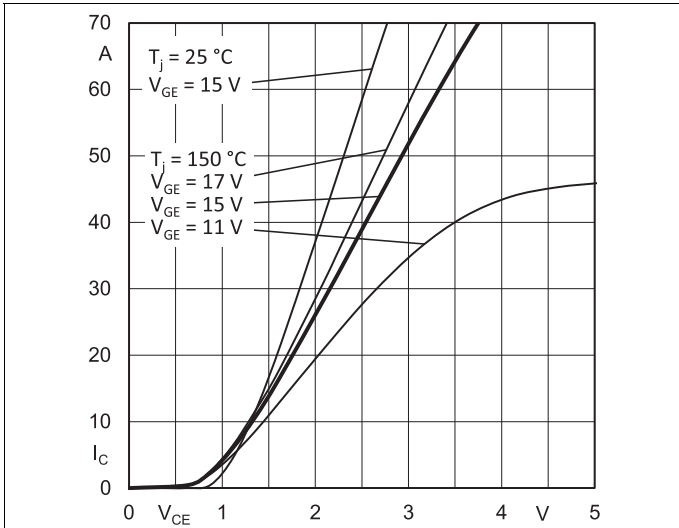

IGBT 7-12 - Fig. 1:
Typ. output characteristic

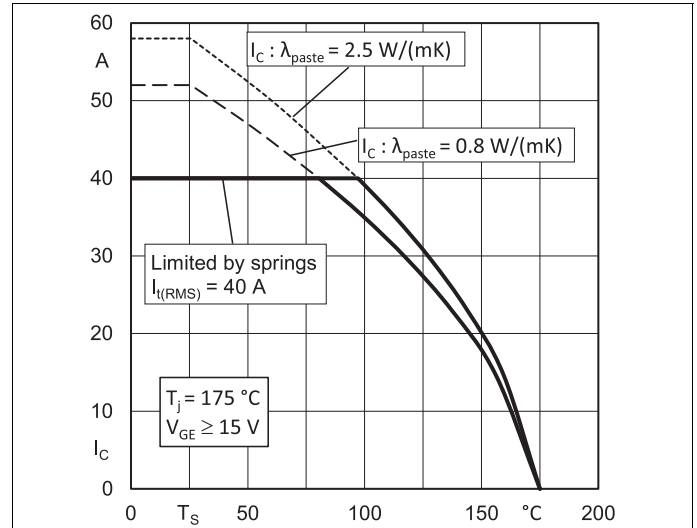

IGBT 7-12 - Fig. 2:
Typ. rated current vs. temperature $I_C = f(T_s)$

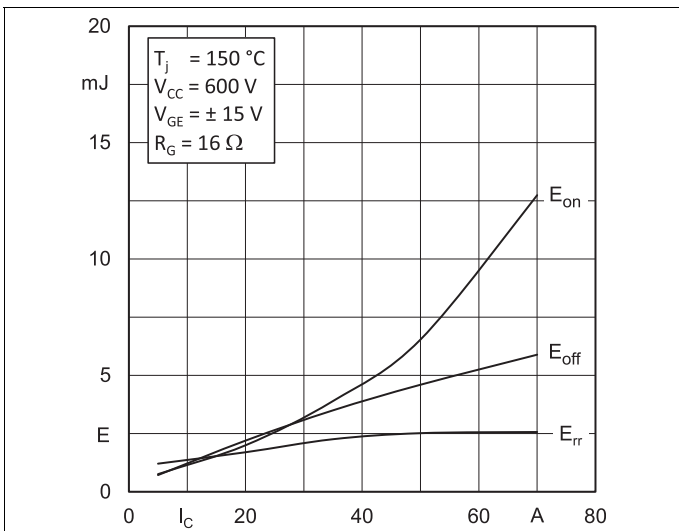

IGBT 7-12 - Fig. 3:
Typ. turn-on /-off energy = $f(I_C)$

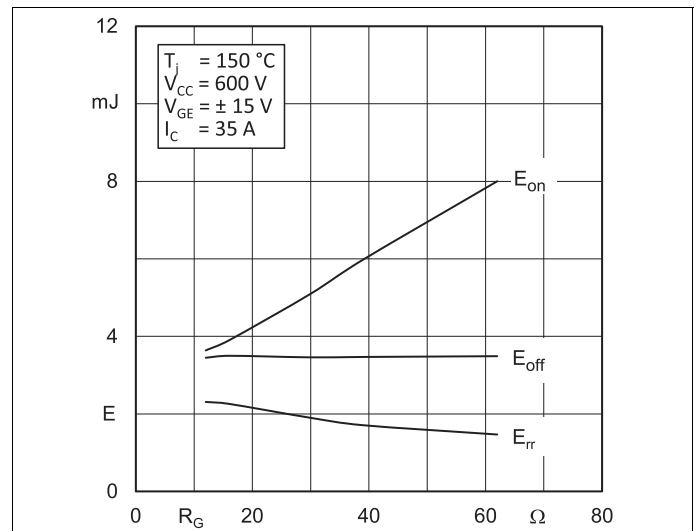

IGBT 7-12 - Fig. 4:
Typ. turn-on /-off energy = $f(R_G)$

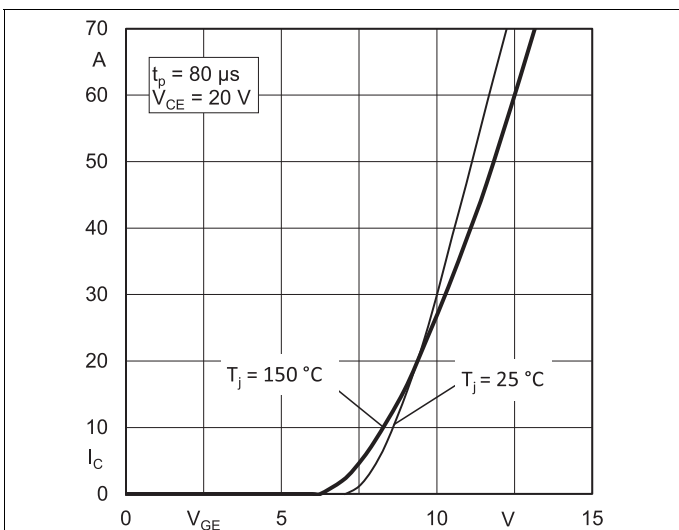

IGBT 7-12 - Fig. 5:
Typ. transfer characteristic

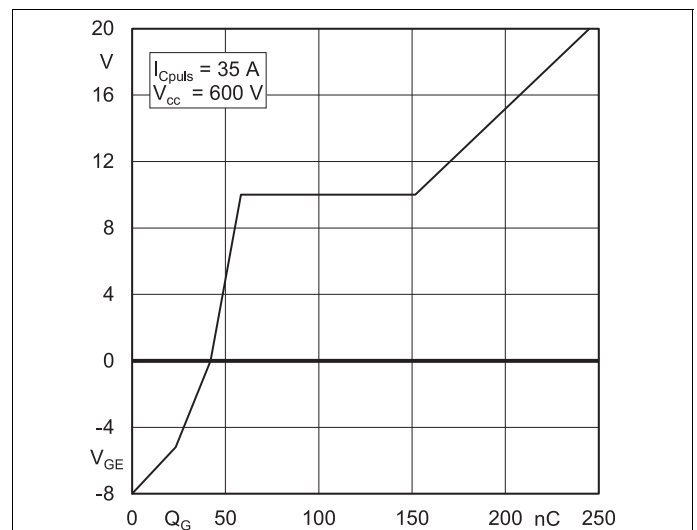

IGBT 7-12 - Fig. 6:
Typ. gate charge characteristic

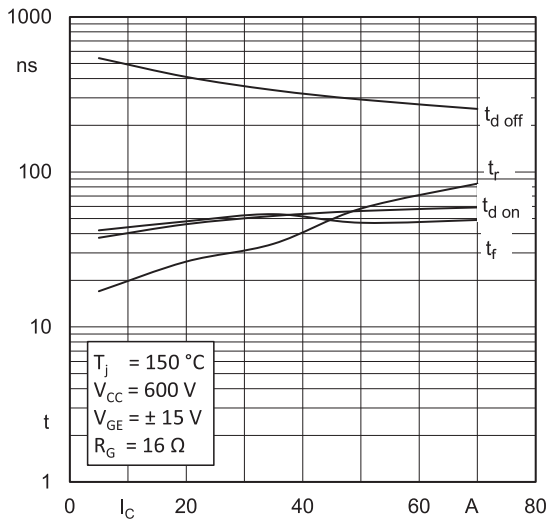

IGBT 7-12 - Fig. 7:
Typ. switching times vs. I_C

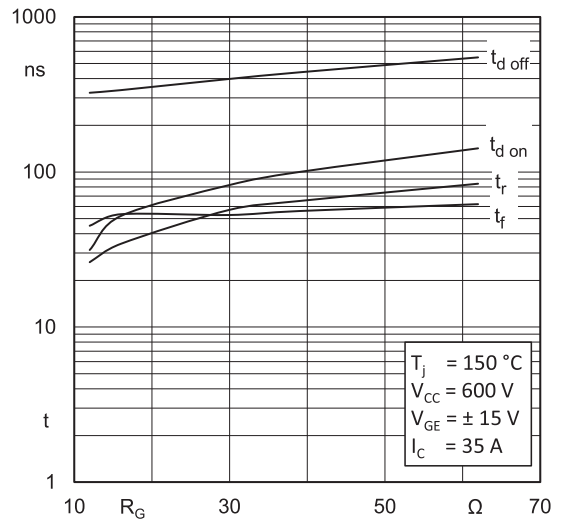

IGBT 7-12 - Fig. 8:
Typ. switching times vs. gate resistor R_G

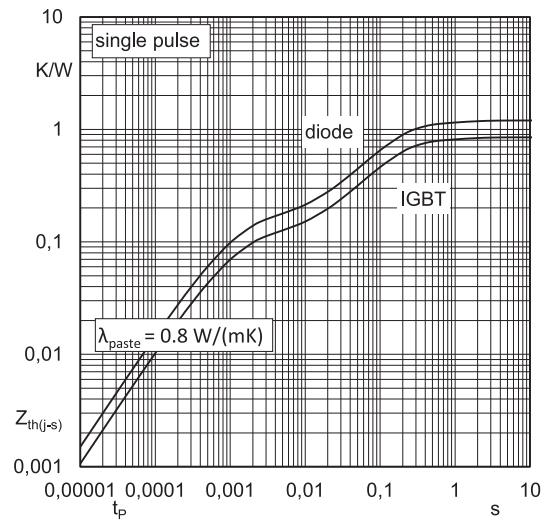

IGBT 7-12 - Fig. 9:
Transient thermal impedance of IGBT and Diode

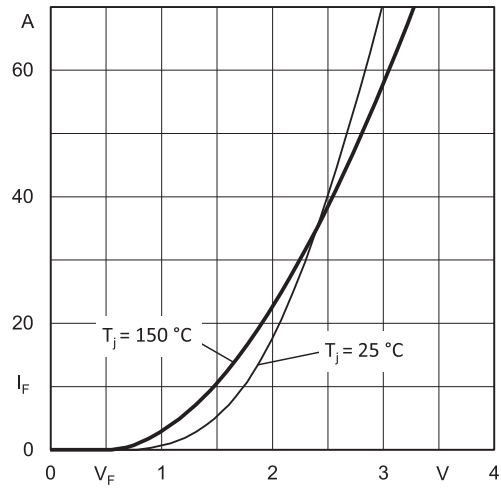

IGBT 7-12 - Fig. 10:
CAL diode forward characteristic

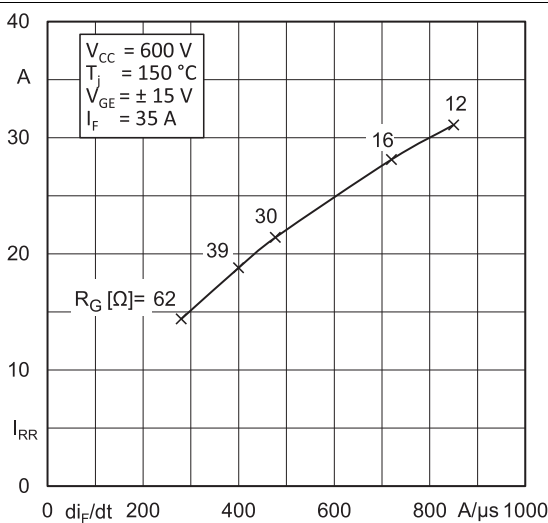

IGBT 7-12 - Fig. 11:
Typ. CAL diode peak reverse recovery current

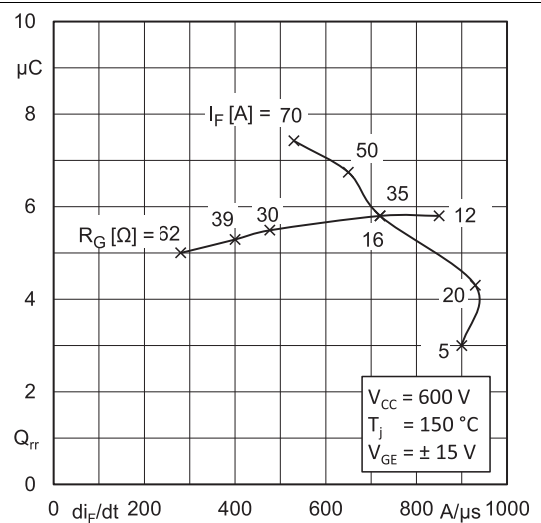

IGBT 7-12 - Fig. 12:
Typ. CAL diode recovery charge

PCB PCB TOP-VIEW

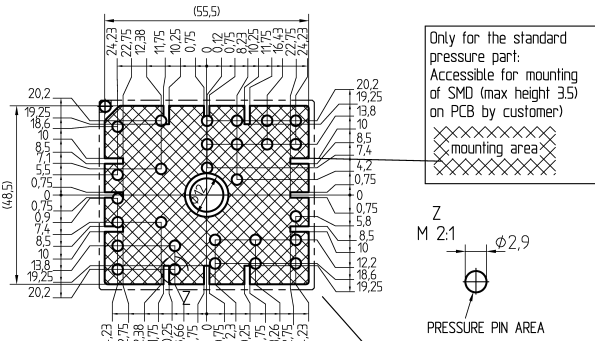

MiniSKiiP 2

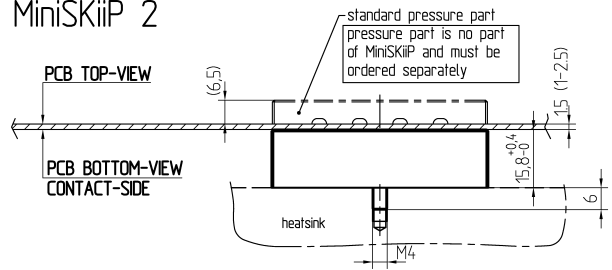

PCB TOP-VIEW

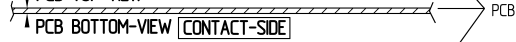

PCB BOTTOM-VIEW CONTACT-SIDE

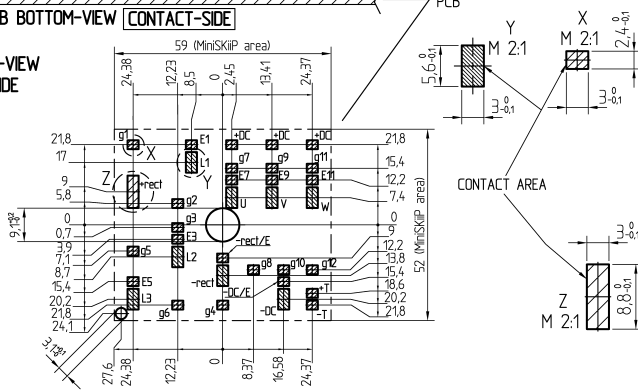

For mounting please follow the assembly instruction

measure: mm

pinout, dimensions

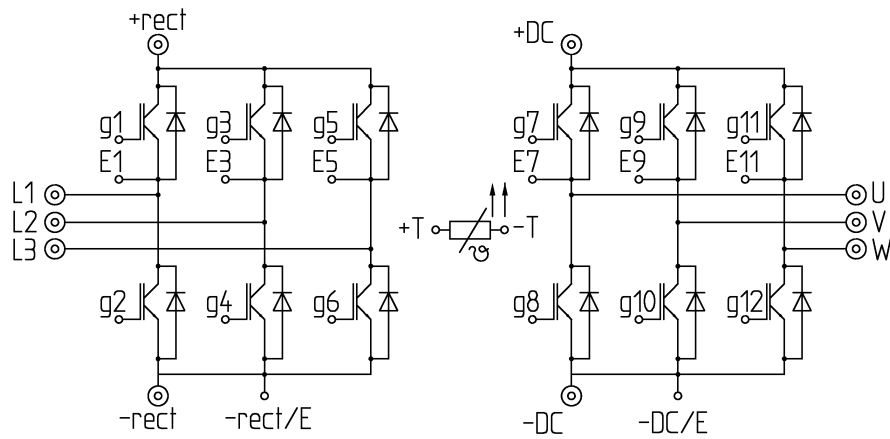

- ⊙ power connector
- control connector

pinout

This is an electrostatic discharge sensitive device (ESDS), international standard IEC 60747-1, chapter IX.

***IMPORTANT INFORMATION AND WARNINGS**

The specifications of SEMIKRON products may not be considered as guarantee or assurance of product characteristics ("Beschaffenheitsgarantie"). The specifications of SEMIKRON products describe only the usual characteristics of products to be expected in typical applications, which may still vary depending on the specific application. Therefore, products must be tested for the respective application in advance. Application adjustments may be necessary. The user of SEMIKRON products is responsible for the safety of their applications embedding SEMIKRON products and must take adequate safety measures to prevent the applications from causing a physical injury, fire or other problem if any of SEMIKRON products become faulty. The user is responsible to make sure that the application design is compliant with all applicable laws, regulations, norms and standards. Except as otherwise explicitly approved by SEMIKRON in a written document signed by authorized representatives of SEMIKRON, SEMIKRON products may not be used in any applications where a failure of the product or any consequences of the use thereof can reasonably be expected to result in personal injury. No representation or warranty is given and no liability is assumed with respect to the accuracy, completeness and/or use of any information herein, including without limitation, warranties of non-infringement of intellectual property rights of any third party. SEMIKRON does not assume any liability arising out of the applications or use of any product; neither does it convey any license under its patent rights, copyrights, trade secrets or other intellectual property rights, nor the rights of others. SEMIKRON makes no representation or warranty of non-infringement or alleged non-infringement of intellectual property rights of any third party which may arise from applications. Due to technical requirements our products may contain dangerous substances. For information on the types in question please contact the nearest SEMIKRON sales office. This document supersedes and replaces all information previously supplied and may be superseded by updates. SEMIKRON reserves the right to make changes.