

SKM400GAL17E4



SEMITRANS® 3

IGBT4 Modules

SKM400GAL17E4

Features

- IGBT4 = 4. generation medium fast trench IGBT (Infineon)
- CAL4 = Soft switching 4. Generation CAL-Diode
- Insulated copper baseplate using DBC Technology (Direct Copper Bonding)
- With integrated Gate resistor
- For switching frequencies up to 8kHz
- UL recognized, file no. E63532

Typical Applications*

- DC/DC – converter
- Brake chopper
- Switched reluctance motor

Remarks

- Case temperature limited to $T_c = 125^\circ\text{C}$ max.
- Recommended $T_{op} = -40 \dots +150^\circ\text{C}$
- Product reliability results valid for $T_j = 150^\circ\text{C}$

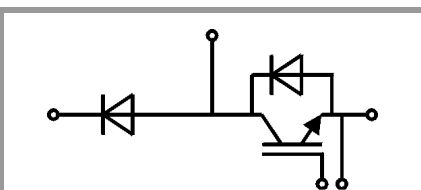

GAL

Absolute Maximum Ratings

Symbol	Conditions	Values	Unit	
IGBT				
V_{CES}	$T_j = 25^\circ\text{C}$	1700	V	
I_C	$T_j = 175^\circ\text{C}$	$T_c = 25^\circ\text{C}$	614	A
		$T_c = 80^\circ\text{C}$	474	A
I_{Cnom}		400	A	
I_{CRM}	$I_{CRM} = 3 \times I_{Cnom}$	1200	A	
V_{GES}		-20 ... 20	V	
t_{psc}	$V_{CC} = 1000\text{ V}$ $V_{GE} \leq 15\text{ V}$ $V_{CES} \leq 1700\text{ V}$	$T_j = 150^\circ\text{C}$	10	μs
T_j		-40 ... 175	$^\circ\text{C}$	
Inverse diode				
I_F	$T_j = 175^\circ\text{C}$	$T_c = 25^\circ\text{C}$	443	A
		$T_c = 80^\circ\text{C}$	327	A
I_{Fnom}		400	A	
I_{FRM}	$I_{FRM} = 2 \times I_{Fnom}$	800	A	
I_{FSM}	$t_p = 10\text{ ms, sin } 180^\circ, T_j = 25^\circ\text{C}$	2340	A	
T_j		-40 ... 175	$^\circ\text{C}$	
Freewheeling diode				
I_F	$T_j = 175^\circ\text{C}$	$T_c = 25^\circ\text{C}$	443	A
		$T_c = 80^\circ\text{C}$	327	A
I_{Fnom}		400	A	
I_{FRM}	$I_{FRM} = 2 \times I_{Fnom}$	800	A	
I_{FSM}	$t_p = 10\text{ ms, sin } 180^\circ, T_j = 25^\circ\text{C}$	2340	A	
T_j		-40 ... 175	$^\circ\text{C}$	
Module				
$I_{t(RMS)}$		500	A	
T_{stg}		-40 ... 125	$^\circ\text{C}$	
V_{isol}	AC sinus 50 Hz, $t = 1\text{ min}$	4000	V	

Characteristics

Symbol	Conditions	min.	typ.	max.	Unit
IGBT					
$V_{CE(sat)}$	$I_C = 400\text{ A}$ $V_{GE} = 15\text{ V}$ chiplevel	$T_j = 25^\circ\text{C}$	1.90	2.20	V
		$T_j = 150^\circ\text{C}$	2.30	2.60	V
V_{CE0}	chiplevel	$T_j = 25^\circ\text{C}$	0.8	0.9	V
		$T_j = 150^\circ\text{C}$	0.7	0.8	V
r_{CE}	$V_{GE} = 15\text{ V}$ chiplevel	$T_j = 25^\circ\text{C}$	2.75	3.25	$\text{m}\Omega$
		$T_j = 150^\circ\text{C}$	4.00	4.50	$\text{m}\Omega$
$V_{GE(th)}$	$V_{GE} = V_{CE}, I_C = 16\text{ mA}$	5.2	5.8	6.4	V
I_{CES}	$V_{GE} = 0\text{ V}$ $V_{CE} = 1700\text{ V}$	$T_j = 25^\circ\text{C}$		5	mA
		$T_j = 150^\circ\text{C}$			mA
C_{ies}	$V_{CE} = 25\text{ V}$		36		nF
C_{oes}	$V_{GE} = 0\text{ V}$		1.36		nF
C_{res}			1.16		nF
Q_G	$V_{GE} = -8\text{ V} \dots +15\text{ V}$		3200		nC
R_{Gint}	$T_j = 25^\circ\text{C}$		1.9		Ω

SKM400GAL17E4



SEMITRANS® 3

IGBT4 Modules

SKM400GAL17E4

Features

- IGBT4 = 4. generation medium fast trench IGBT (Infineon)
- CAL4 = Soft switching 4. Generation CAL-Diode
- Insulated copper baseplate using DBC Technology (Direct Copper Bonding)
- With integrated Gate resistor
- For switching frequencies up to 8kHz
- UL recognized, file no. E63532

Typical Applications*

- DC/DC – converter
- Brake chopper
- Switched reluctance motor

Remarks

- Case temperature limited to $T_c = 125^\circ\text{C}$ max.
- Recommended $T_{op} = -40 \dots +150^\circ\text{C}$
- Product reliability results valid for $T_j = 150^\circ\text{C}$

Characteristics						
Symbol	Conditions		min.	typ.	max.	Unit
$t_{d(on)}$	$V_{CC} = 1200\text{ V}$	$T_j = 150^\circ\text{C}$		280		ns
t_r	$I_C = 400\text{ A}$	$T_j = 150^\circ\text{C}$		45		ns
E_{on}	$V_{GE} = +15/-15\text{ V}$	$T_j = 150^\circ\text{C}$		156.5		mJ
$t_{d(off)}$	$R_{G\ on} = 2\ \Omega$	$T_j = 150^\circ\text{C}$		760		ns
t_f	$R_{G\ off} = 1\ \Omega$	$T_j = 150^\circ\text{C}$		140		ns
E_{off}	μs $di/dt_{off} = 2300\text{ A}/\mu\text{s}$ $du/dt = 5600\text{ V}/\mu\text{s}$	$T_j = 150^\circ\text{C}$		180		mJ
$R_{th(j-c)}$	per IGBT				0.066	K/W
Inverse diode						
$V_F = V_{EC}$	$I_F = 400\text{ A}$	$T_j = 25^\circ\text{C}$		2.00	2.40	V
	$V_{GE} = 0\text{ V}$ chipelevel	$T_j = 150^\circ\text{C}$		2.15	2.57	V
V_{F0}	chipelevel	$T_j = 25^\circ\text{C}$		1.32	1.56	V
		$T_j = 150^\circ\text{C}$		1.08	1.22	V
r_F	chipelevel	$T_j = 25^\circ\text{C}$		1.7	2.1	m Ω
		$T_j = 150^\circ\text{C}$		2.7	3.4	m Ω
I_{RRM}	$I_F = 400\text{ A}$	$T_j = 150^\circ\text{C}$		615		A
Q_{rr}	$di/dt_{off} = 10100\text{ A}/\mu\text{s}$	$T_j = 150^\circ\text{C}$		150		μC
E_{rr}	$V_{GE} = \pm 15\text{ V}$ $V_{CC} = 1200\text{ V}$	$T_j = 150^\circ\text{C}$		130		mJ
$R_{th(j-c)}$	per diode				0.13	K/W
Freewheeling diode						
$V_F = V_{EC}$	$I_F = 400\text{ A}$	$T_j = 25^\circ\text{C}$		2.00	2.40	V
	$V_{GE} = 0\text{ V}$ chipelevel	$T_j = 150^\circ\text{C}$		2.15	2.57	V
V_{F0}	chipelevel	$T_j = 25^\circ\text{C}$		1.32	1.56	V
		$T_j = 150^\circ\text{C}$		1.08	1.22	V
r_F	chipelevel	$T_j = 25^\circ\text{C}$		1.7	2.1	m Ω
		$T_j = 150^\circ\text{C}$		2.7	3.4	m Ω
I_{RRM}	$I_F = 400\text{ A}$	$T_j = 150^\circ\text{C}$		615		A
Q_{rr}	$di/dt_{off} = 10100\text{ A}/\mu\text{s}$	$T_j = 150^\circ\text{C}$		150		μC
E_{rr}	$V_{GE} = \pm 15\text{ V}$ $V_{CC} = 1200\text{ V}$	$T_j = 150^\circ\text{C}$		130.3		mJ
$R_{th(j-c)}$	per Diode				0.13	K/W
Module						
L_{CE}				15		nH
R_{CC+EE}	terminal-chip	$T_c = 25^\circ\text{C}$		0.55		m Ω
		$T_c = 125^\circ\text{C}$		0.85		m Ω
$R_{th(c-s)}$	per module			0.02	0.038	K/W
M_s	to heat sink M6		3		5	Nm
M_t		to terminals M6	2.5		5	Nm
						Nm
w					325	g

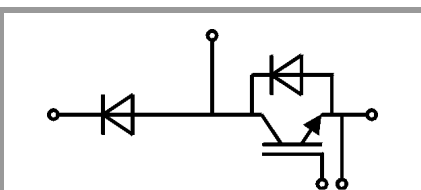

GAL

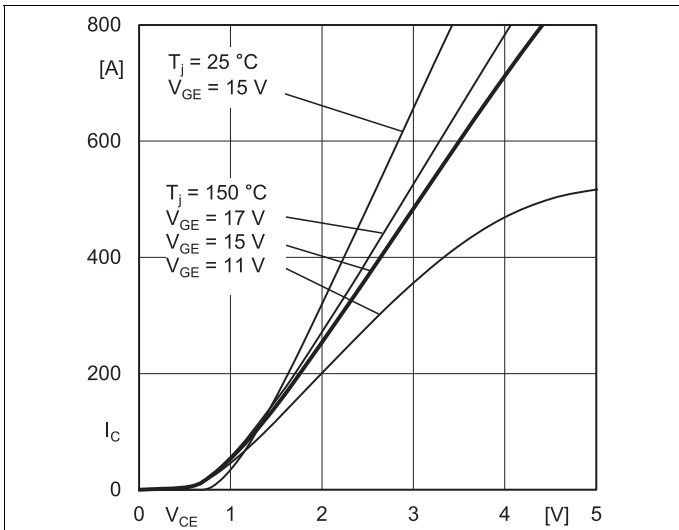

Fig. 1: Typ. output characteristic, inclusive $R_{CC'+EE'}$

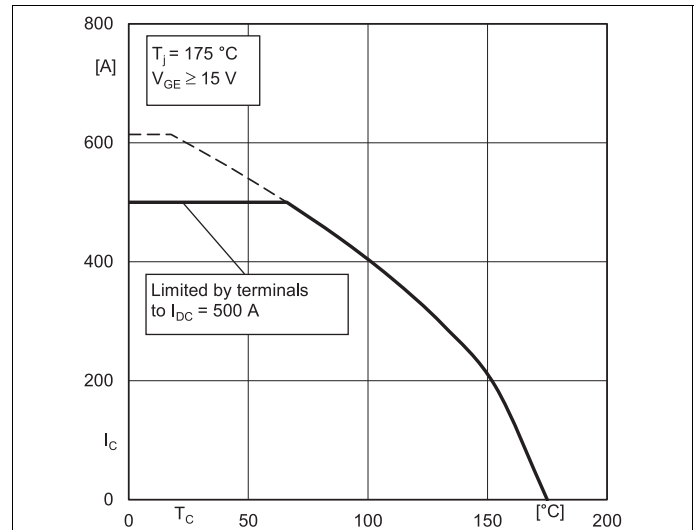

Fig. 2: Rated current vs. temperature $I_C = f(T_C)$

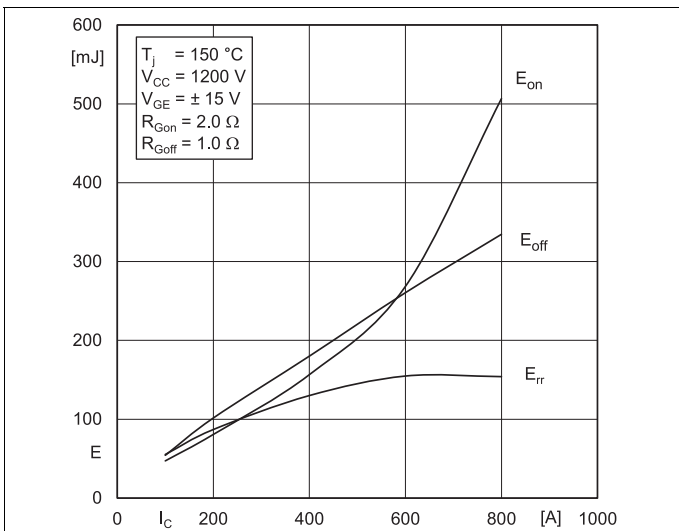

Fig. 3: Typ. turn-on /-off energy = $f(I_C)$

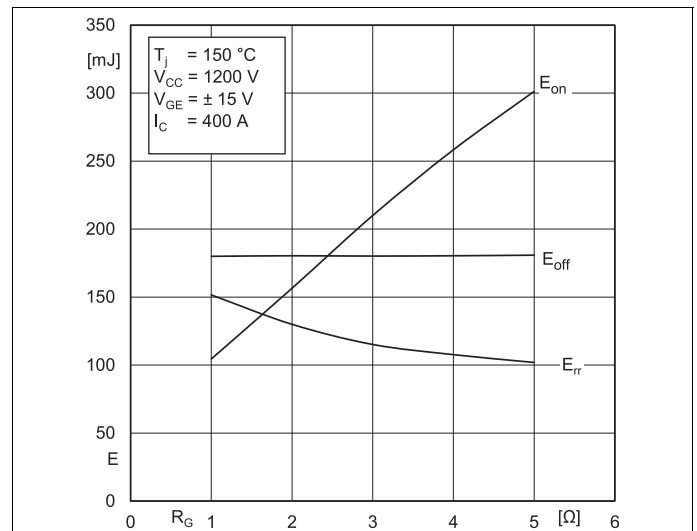

Fig. 4: Typ. turn-on /-off energy = $f(R_G)$

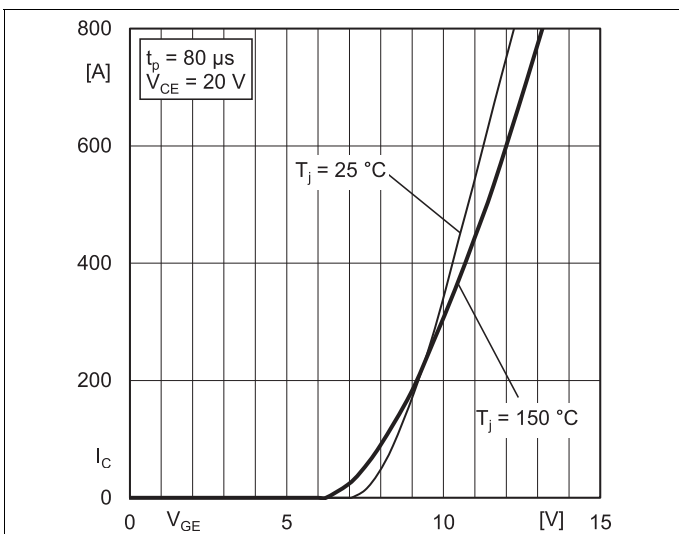

Fig. 5: Typ. transfer characteristic

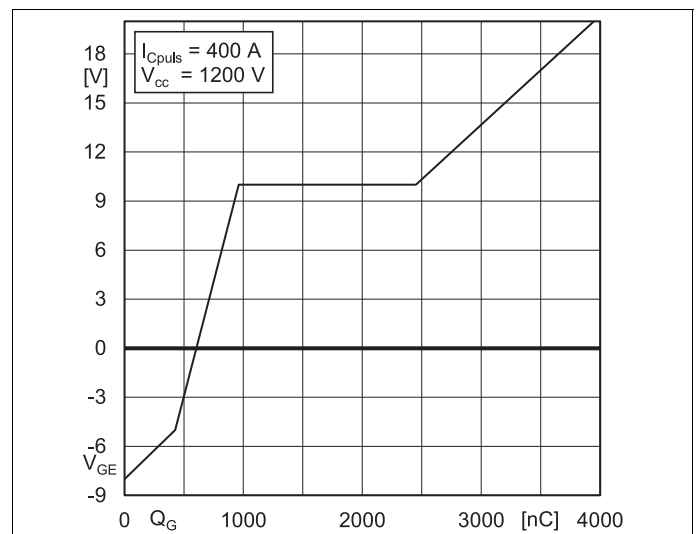

Fig. 6: Typ. gate charge characteristic

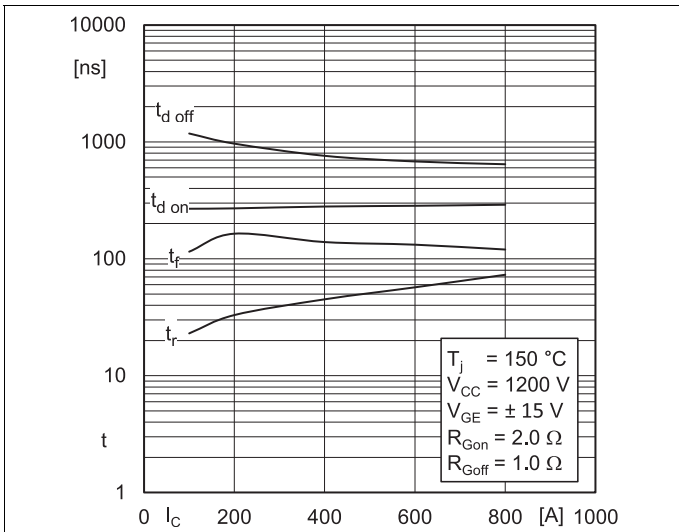

Fig. 7: Typ. switching times vs. I_C

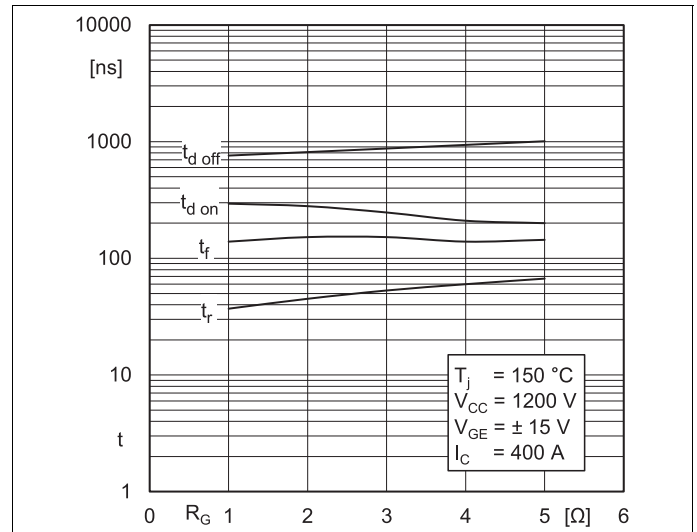

Fig. 8: Typ. switching times vs. gate resistor R_G

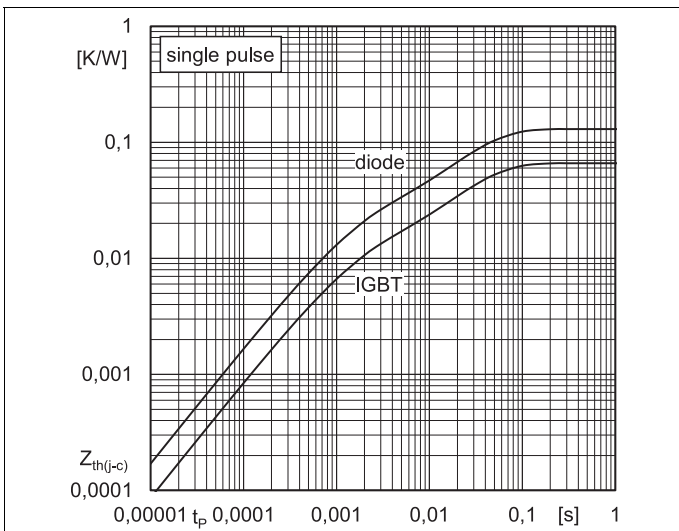

Fig. 9: Transient thermal impedance

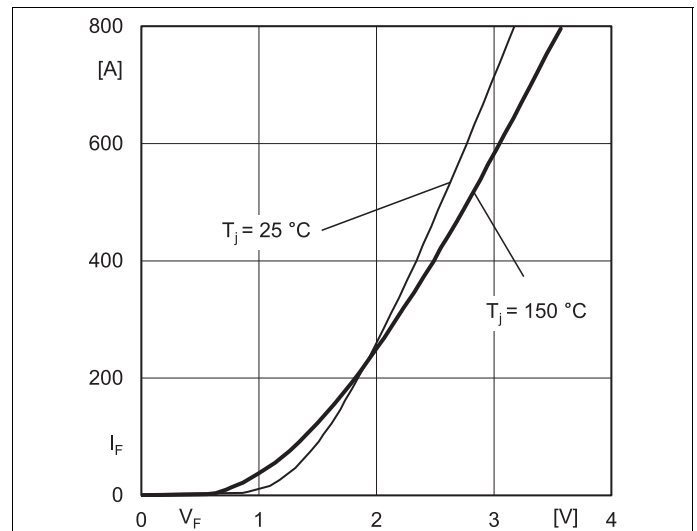

Fig. 10: Typ. CAL diode forward charact., incl. R_{CC+EE}

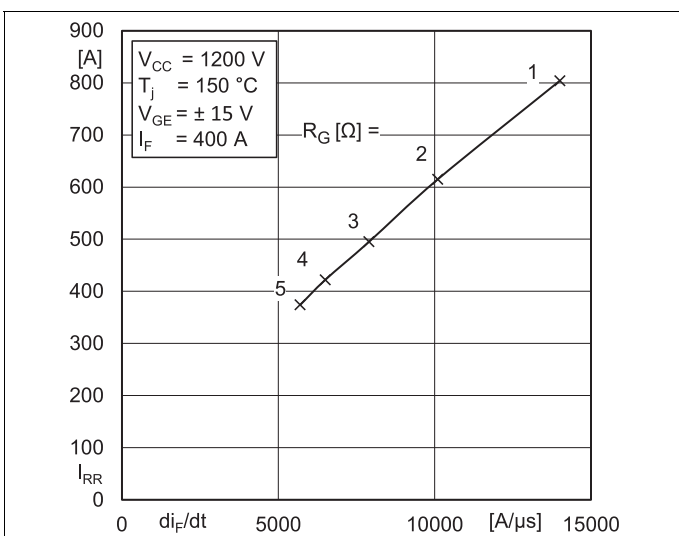

Fig. 11: CAL diode peak reverse recovery current

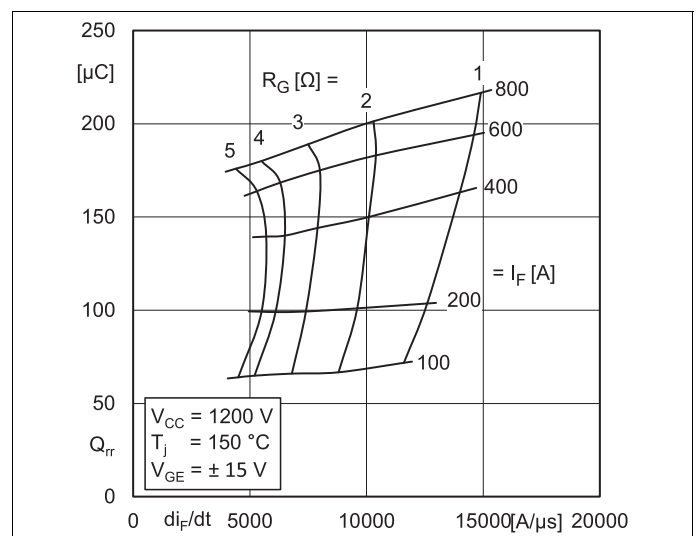
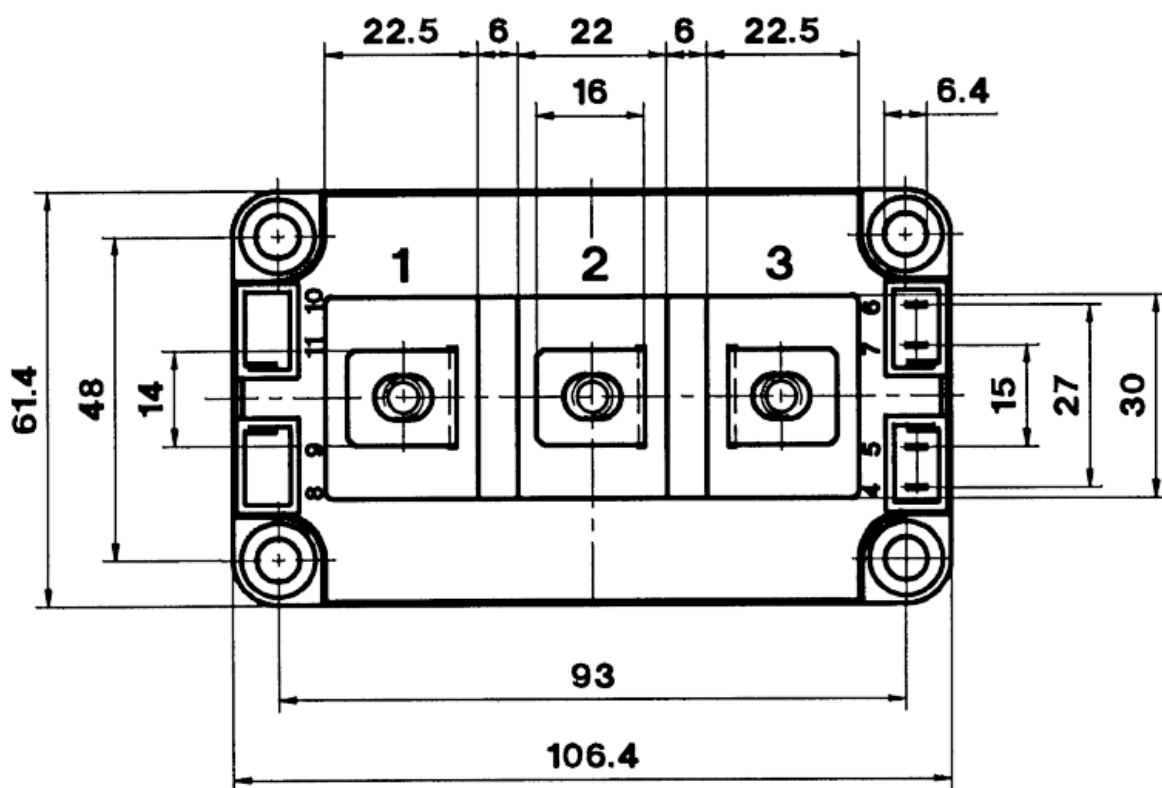
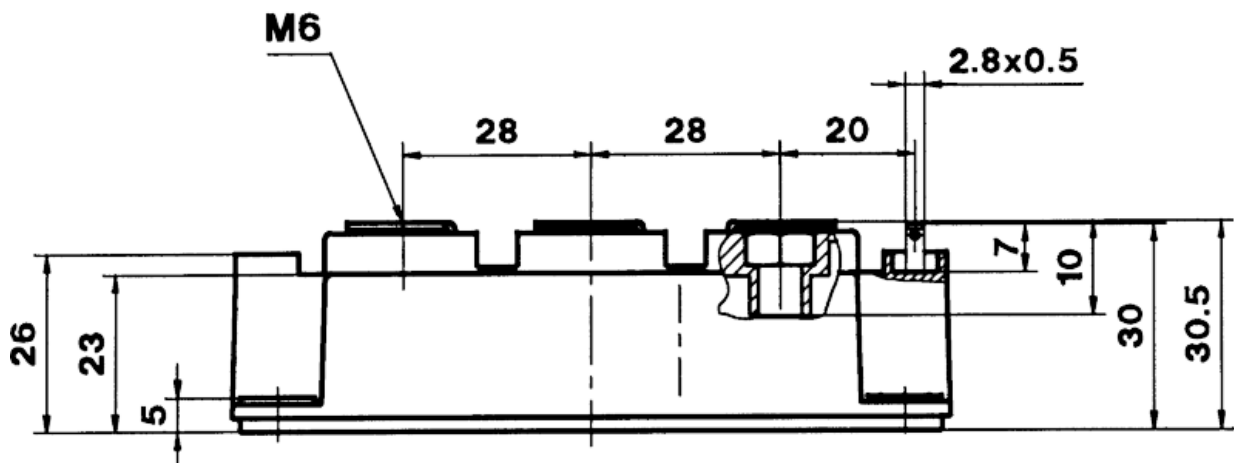
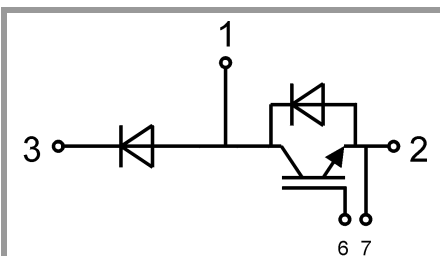

Fig. 12: Typ. CAL diode peak reverse recovery charge



SEMITRANS 3



GAL

This is an electrostatic discharge sensitive device (ESDS), international standard IEC 60747-1, Chapter IX

* The specifications of our components may not be considered as an assurance of component characteristics. Components have to be tested for the respective application. Adjustments may be necessary. The use of SEMIKRON products in life support appliances and systems is subject to prior specification and written approval by SEMIKRON. We therefore strongly recommend prior consultation of our staff.