

Board 3s SKYPER 32PRO R



SKYPER®

Adaptor board

Board 3s SKYPER 32PRO R

Preliminary Data

Features

- Two output channels
- Gold finish

Typical Applications*

- Adaptor board for SKYPER 32 IGBT drivers in bridge circuits for industrial applications
- DC bus up to 1200V

Footnotes

All characteristics listed in the data sheet are guilty for the use with SKYPER 32. Please consider the derating of the ambient temperature. Please refer to the datasheet of SKYPER 32 for further information.

Absolute Maximum Ratings			
Symbol	Conditions	Values	Unit
V_s	Supply voltage primary	16	V
$I_{outPEAK}$	Output peak current	15	A
$I_{outAVmax}$	Output average current	50	mA
f_{max}	max. switching frequency	50	kHz
V_{CE}	Collector emitter voltage sense across the IGBT	1700	V
V_{isolIO}	Isolation test voltage input - output (AC, rms, 2s)	4000	V
V_{isolPD}	Partial discharge extinction voltage, rms, $Q_{PD} \leq 10pC$	1500	V
V_{isol12}	Isolation test voltage output 1 - output 2 (AC, rms, 2s)	1500	V
$R_{Gon\ min}$		1.5	Ω
$R_{Goff\ min}$	Minimum rating for external R_{Goff}	1.5	Ω
T_{op}	Operating temperature	-25 ... 85	$^{\circ}C$
T_{stg}	Storage temperature	-25 ... 85	$^{\circ}C$

Characteristics					
Symbol	Conditions	min.	typ.	max.	Unit
V_s	Supply voltage primary side	14.4	15	15.6	V
V_j	input signal voltage on / off		15 / 0		V
V_{IT+}	Input threshold voltage HIGH			12.3	V
V_{IT-}	Input threshold voltage (LOW)	4.6			V
$V_{G(on)}$	Turn on gate voltage output		15		V
$V_{G(off)}$	Turn off gate voltage output		-7		V
$t_{d(on)IO}$	Input-output turn-on propagation time		1.2		μs
$t_{d(off)IO}$	Input-output turn-off propagation time		1.2		μs

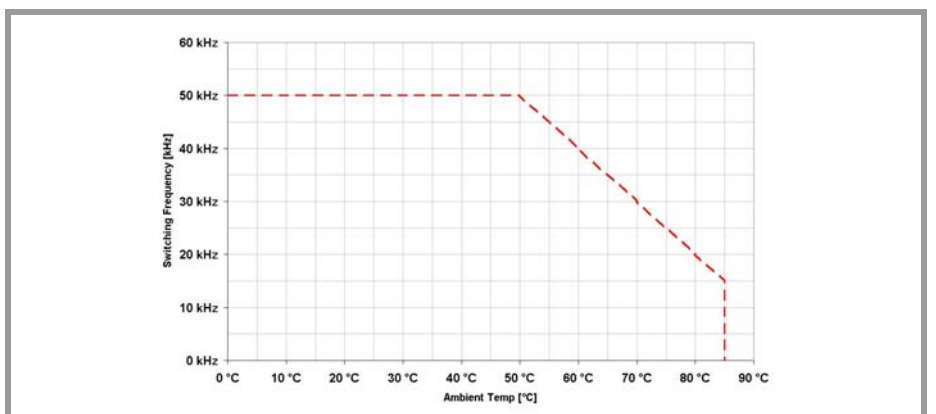

Derating

This is an electrostatic discharge sensitive device (ESDS), international standard IEC 60747-1, Chapter IX

* The specifications of our components may not be considered as an assurance of component characteristics. Components have to be tested for the respective application. Adjustments may be necessary. The use of SEMIKRON products in life support appliances and systems is subject to prior specification and written approval by SEMIKRON. We therefore strongly recommend prior consultation of our personal.

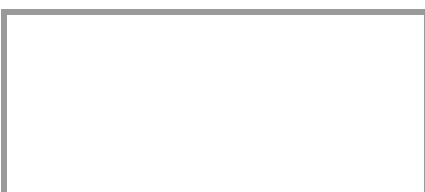

Adaptor board

Adaptor Board 3s SKYPER[®] 32PRO R

Technical Explanations

Revision 02

This Technical Explanation is valid for the following parts:

part number	type	date code (YYWW)
L5062601	Board 3s SKYPER [®] 32PRO R	≥ 1131

Related documents:

title
Technical Explanations SKYPER [®] 32PRO R

Prepared by: Johannes Krapp

Content

Application and Handling Instructions	3
Further application support	3
General Description	3
Dimensions	4
Component Placement Layout	5
PIN Array	6
Signal IF_CMN_nHALT	7
Setting Dead Time	7
Setting Dynamic Short Circuit Protection	7
Collector Series Resistance	8
Adaptation Gate Resistors	8
Adaptation Decoupling Gate Resistors	8
Setting Soft Turn-Off	9
Temperature Signal	9
Over Temperature Protection Circuit (OTP)	9
Mounting Notes	10
Schematics	11
Parts List	14

Please note:

All values in this technical explanation are typical values. Typical values are the average values expected in large quantities and are provided for information purposes only. These values can and do vary in different applications. All operating parameters should be validated by user's technical experts for each application.

Application and Handling Instructions

- Please provide for static discharge protection during handling. As long as the hybrid driver is not completely assembled, the input terminals have to be short-circuited. Persons working with devices have to wear a grounded bracelet. Any synthetic floor coverings must not be statically chargeable. Even during transportation the input terminals have to be short-circuited using, for example, conductive rubber. Worktables have to be grounded. The same safety requirements apply to MOSFET- and IGBT-modules.
- Any parasitic inductances within the DC-link have to be minimised. Over-voltages may be absorbed by C- or RCD-snubber networks between main terminals for PLUS and MINUS of the power module.
- When first operating a newly developed circuit, SEMIKRON recommends to apply low collector voltage and load current in the beginning and to increase these values gradually, observing the turn-off behaviour of the free-wheeling diode and the turn-off voltage spikes generated across the IGBT. An oscillographic control will be necessary. Additionally, the case temperature of the module has to be monitored. When the circuit works correctly under rated operation conditions, short-circuit testing may be done, starting again with low collector voltage.
- It is important to feed any errors back to the control circuit and to switch off the device immediately in failure events. Repeated turn-on of the IGBT into a short circuit with a high frequency may destroy the device.
- The inputs of the hybrid driver are sensitive to over-voltage. Voltages higher than $V_S + 0,3V$ or below $-0,3V$ may destroy these inputs. Therefore, control signal over-voltages exceeding the above values have to be avoided.
- The connecting leads between hybrid driver and the power module should be as short as possible (max. 20cm), the driver leads should be twisted.

Further application support

Latest information is available at <http://www.semikron.com>. For design support please read the SEMIKRON Application Manual Power Modules available at <http://www.semikron.com>.

General Description

The Board 3s SKYPER[®] 32PRO R is an adaptor board for the IGBT module SEMiX[®] 3s (spring contact version). The board can be customized allowing adaptation and optimization to the used SEMiX[®] Module.

The switching characteristic of the IGBT can be influenced through user settings, e.g. changing turn-on and turn-off speed by variation of R_{Gon} and R_{Goff} . Furthermore, it is possible to adjust the monitoring level and blanking time for the DSCP (see Technical Explanations SKYPER[®] 32PRO R).

Please note:

This technical explanation is based on the Technical Explanations for SKYPER[®] 32PRO R. Please read the Technical Explanations SKYPER[®] 32 PRO R before using the Adaptor Board.

Board 3s SKYPER[®] 32PRO R



Component Placement Layout

Adaptor Board

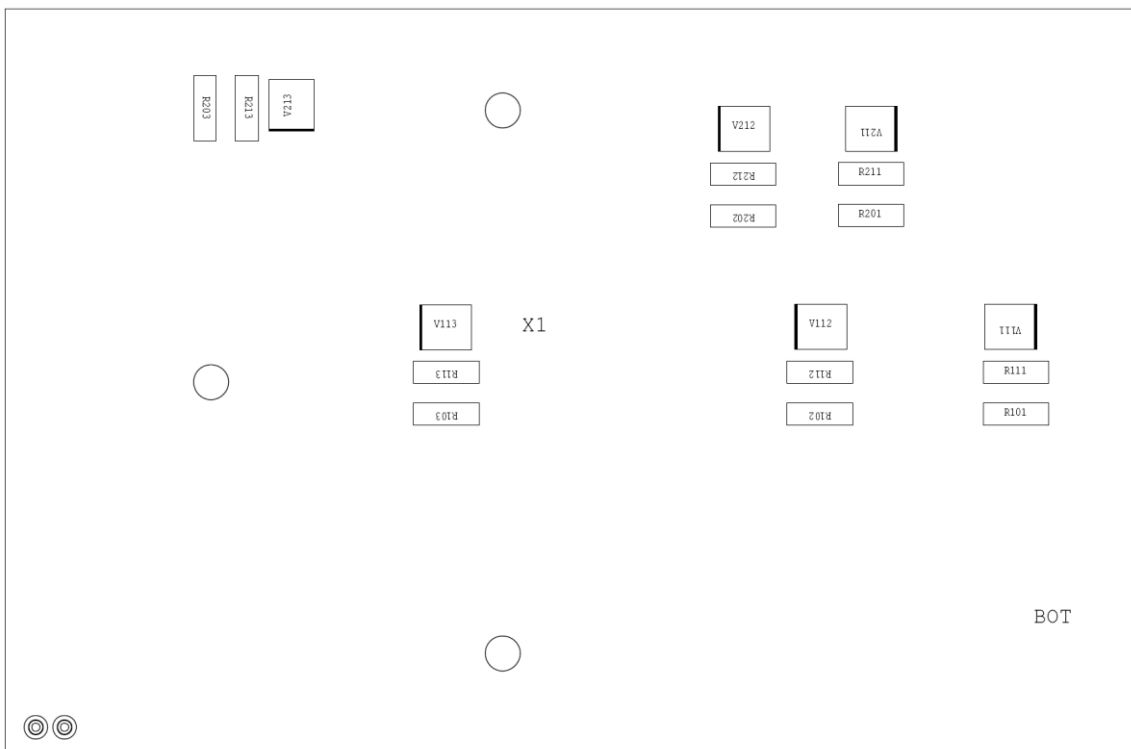
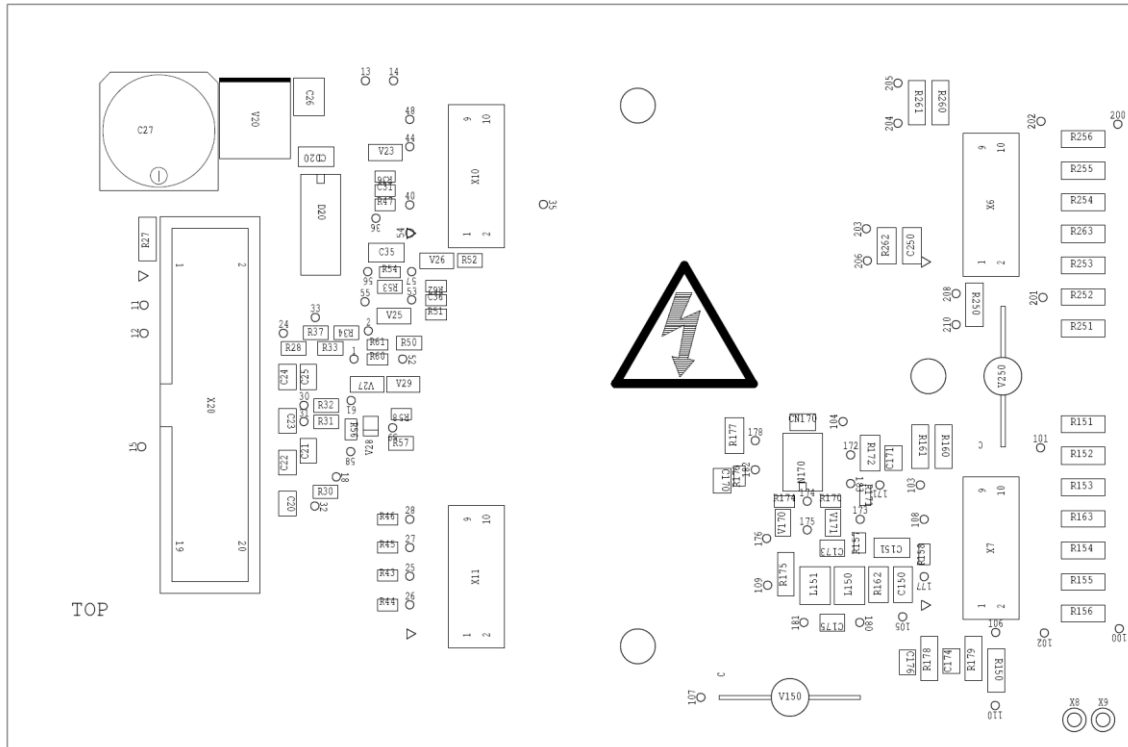

PIN Array

Connector X20 (ODU FLAKAFIX 511.068.803.020)	
	<p>Product information of suitable female connectors and distributor contact information is available at e.g. http://www.harting.com (part number 09 18 520 6 813).</p>

PIN	Signal	Function	Specification
X20:01	IF_PWR_15P	Drive power supply	Stabilised +15V ±4%
X20:02	IF_PWR_GND	GND for power supply	
X20:03	IF_PWR_15P	Drive power supply	Stabilised +15V ±4%
X20:04	IF_PWR_GND	GND for power supply	
X20:05	IF_PWR_15P	Drive power supply	Stabilised +15V ±4%
X20:06	IF_PWR_GND	GND for power supply	
X20:07	reserved		
X20:08	IF_PWR_GND	GND for power supply	
X20:09	IF_CMN_nHALT	Driver core status signal (bidirectional signal with dominant recessive behaviour)	Digital 15V logic; LOW (dominant) = driver disabled; HIGH (recessive) = ready to operate
X20:10	reserved		
X20:11	reserved		
X20:12	IF_CMN_GND	GND for signal IF_CMN_nHALT	
X20:13	reserved		
X20:14	reserved		
X20:15	IF_HB_TOP	Switching signal input (TOP switch)	Digital 15 V logic; 10 kOhm impedance; LOW = TOP switch off; HIGH = TOP switch on
X20:16	IF_HB_BOT	Switching signal input (BOTTOM switch)	Digital 15 V logic; 10 kOhm impedance; LOW = BOT switch off; HIGH = BOT switch on
X20:17	reserved		
X20:18	IF_HB_GND	GND for signals IF_HB_TOP & F_HB_BOT	
X20:19	reserved		
X20:20	reserved		

Signal IF_CMN_nHALT

The Halt Logic Signals PRIM_HALT_IN and PRIM_HALT_OUT of the driver core are coupled to one bidirectional signal (IF_CMN_nHALT) with dominant recessive behaviour. IF_CMN_nHALT shows the driver core status. When IF_CMN_nHALT is HIGH (recessive), the driver core is ready to operate. When IF_CMN_nHALT is LOW (dominant), the driver core is disabled / not ready to operate because of e. g. detected failure or driver core system start.

A controller can hold with the IF_CMN_nHALT signal the driver core in a safe state (e.g. during a start up of a system or gathered failure signal of other hardware) or generate a coeval release of paralleled driver. Furthermore, paralleled drivers can send and receive IF_CMN_nHALT signals among each other by using a single-wire bus.

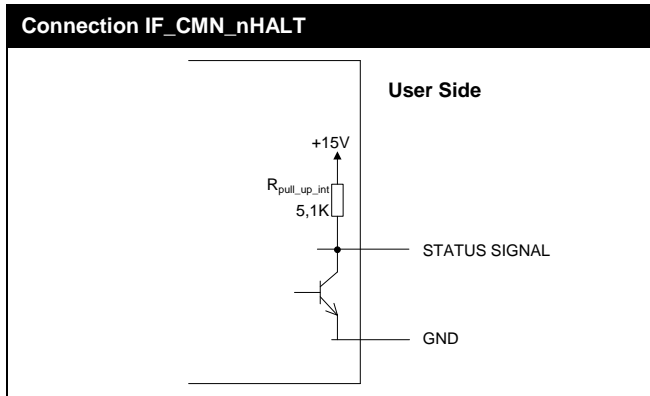

Setting Dead Time

DT adjustment

Designation	Pattern Name	Setting
R43 (connected to GND)	0603	PRIM_CFG_TDT2_IN Factory setting: 0Ω
R44 (connected to GND)	0603	PRIM_CFG_SELECT_IN Factory setting: not equipped
R45 (connected to GND)	0603	PRIM_CFG_TDT3_IN Factory setting: 0Ω
R46 (connected to GND)	0603	PRIM_CFG_TDT1_IN Factory setting: not equipped

Factory setting: 3,3μs

Setting Dynamic Short Circuit Protection

R_{CE} & C_{CE}

Designation	Pattern Name	Setting
R162	1206	R _{CE} Factory setting: not equipped TOP
C150	1206	C _{CE} Factory setting: not equipped TOP
R262	1206	R _{CE} Factory setting: not equipped BOT
C250	1206	C _{CE} Factory setting: not equipped BOT

Collector Series Resistance

R_{VCE}			
Designation	Pattern Name	Setting	
R150	MiniMELF	R_{VCE}^* Factory setting: not equipped	TOP
R250	MiniMELF	R_{VCE}^* Factory setting: not equipped	BOT

* 1200V IGBT operation: 0 Ω
1700V IGBT operation: 1k Ω / 0,4W

Adaptation Gate Resistors

R_{Gon} & R_{Goff}			
Designation	Pattern Name	Setting	
R151, R152, R153 (parallel connected)	MiniMELF	R_{Gon} Factory setting: not equipped	TOP
R154, R155, R156 (parallel connected)	MiniMELF	R_{Goff} Factory setting: not equipped	TOP
R251, R252, R253 (parallel connected)	MiniMELF	R_{Gon} Factory setting: not equipped	BOT
R254, R255, R256 (parallel connected)	MiniMELF	R_{Goff} Factory setting: not equipped	BOT

Adaptation Decoupling Gate Resistors

For details to the decoupling gate resistors and recommended values, see Modules Explanations and Data Sheets SEMiX[®].

R_{G1} , R_{G2} , R_{G3}			
Designation	Pattern Name	Setting	
R101	MELF	R_{G1} Factory setting: not equipped	TOP
R102	MELF	R_{G2} Factory setting: not equipped	TOP
R103	MELF	R_{G3} Factory setting: not equipped	TOP
R201	MELF	R_{G1} Factory setting: not equipped	BOT
R202	MELF	R_{G2} Factory setting: not equipped	BOT
R203	MELF	R_{G3} Factory setting: not equipped	BOT

Setting Soft Turn-Off

R _{Goff_SC}			
Designation	Pattern Name	Setting	
R160, R161 (parallel connected)	MiniMELF	R _{Goff_SC} Factory setting: not equipped	TOP
R260, R261 (parallel connected)	MiniMELF	R _{Goff_SC} Factory setting: not equipped	BOT

Temperature Signal

The temperature sensor inside the SEMiX[®] module is directly connected to contacting points T1 and T2. For details to the temperature sensor, see Modules Explanations SEMiX[®].

Safety Warnings:



The contacting points T1 and T2 are not electrical isolated. Due to high voltage that may be present at the contacting points T1 and T2, some care must be taken in order to avoid accident. There is no cover or potential isolation that protect the high voltage sections / wires from accidental human contact.

Please note:

If the contacting points T1 and T2 are used for adaptor of the temperature sensor, the Over Temperature Protection Circuit must be disabled by taking out the resistors R175, R178 and R179.

Over Temperature Protection Circuit (OTP)

The external error input SEC_TOP_ERR_IN on the secondary side (high potential) of the driver core is used for an over temperature protection circuit to place the gate driver into halt mode.

Dimensioning OTP

1. Define an over temperature trip level according to the application.
2. Calculate the nominal ohmic resistance value of the temperature sensor at the defined trip level (see "Modules – Explanations - SEMiX[®]" on SEMiX[®] product overview page at <http://www.semikron.com>).
3. The trip level on the adapter board is set with R172 by using the calculated resistance value.
 - **Factory setting R172: not equipped**
 - **If no resistor is used, a failure signal is generated.**

Mounting Notes

The electrical connections between adaptor board and SEMiX[®] are realised via spring contacts integrated in SEMiX[®] power modules and via landing pads on the bottom side of the adaptor board.

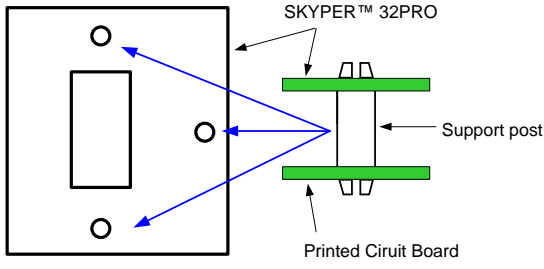
Adaptor Board & Driver Core Mounting	
	<ol style="list-style-type: none"> Soldering of components (e.g. R_{Gon}, R_{Goff}, etc.) on adaptor board. Adaptor Board has to be fixed to the SEMiX[®] module (see "Mounting Instruction and Application Notes for SEMiX[®] IGBT modules" on SEMiX[®] product overview page at http://www.semikron.com). Insert driver core into the box connector on adaptor board.
	<p>The connection between driver core and adaptor board should be mechanical reinforced by using support posts. The posts have to be spaced between driver core and adaptor board.</p> <p>Product information of suitable support posts and distributor contact information is available at e.g. http://www.richco-inc.com (e.g. part number DLMSPM-8-01, LCBST-8-01).</p>

Schematic III Adaptor Board

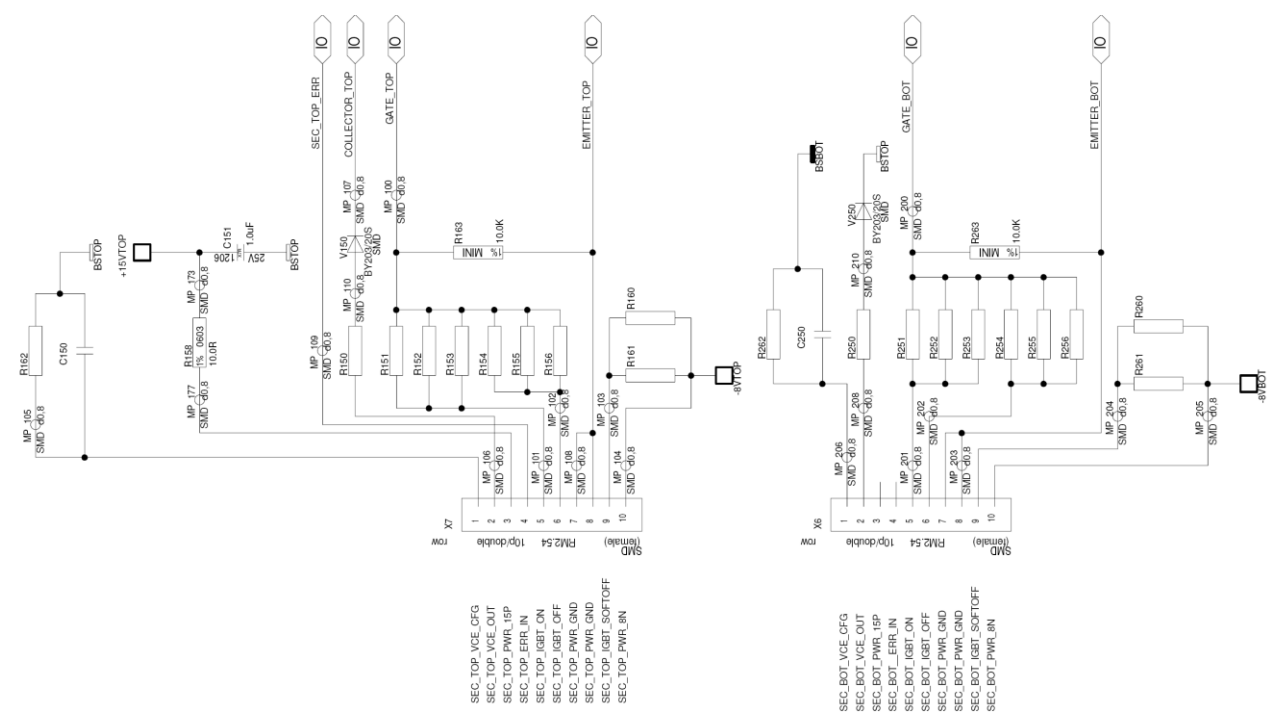
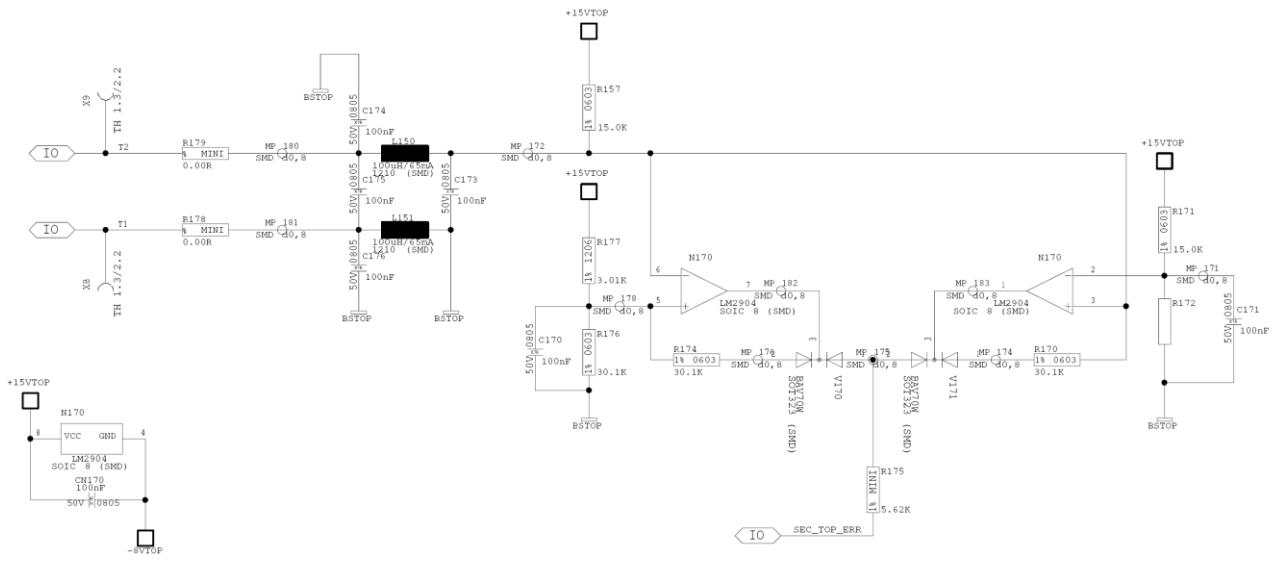

- SEC_TOP_VCE_CFG
- SEC_TOP_VCE_OUT
- SEC_TOP_PWR_TEP
- SEC_TOP_ERR_IN
- SEC_TOP_IGBT_ON
- SEC_TOP_IGBT_OFF
- SEC_TOP_PWR_GND
- SEC_TOP_IGBT_SOFTOFF
- SEC_TOP_PWR_IN

- SEC_BOT_VCE_CFG
- SEC_BOT_VCE_OUT
- SEC_BOT_PWR_INP
- SEC_BOT_ERR_LN
- SEC_BOT_IGBT_ON
- SEC_BOT_IGBT_OFF
- SEC_BOT_PWR_GND
- SEC_BOT_PWR_GND
- SEC_BOT_IGBT_SOFTOFF
- SEC_BOT_PWR_IN

Parts List

Parts List Adaptor Board				
Count	Ref. Designator	Value	Pattern Name	Description
7	C170, C171, C173, C174, C175, C176, CN170	100nF	0805 (SMD)	Capacitor X7R
6	C20, C21, C22, C23, C24, C25	1nF	0805 (SMD)	Capacitor X7R
1	C26	2,2µF	1210 (SMD)	Capacitor X7R
1	C27	220uF/35V	SMD	Longlife-Elko
1	C31	68pF	0603 (SMD)	Capacitor NP0
2	C35, C151	1uF	1206 (SMD)	Capacitor X7R
1	C36	100pF	0603 (SMD)	Capacitor NP0
1	CD20	100nF	1206 (SMD)	Capacitor X7R
1	D20	74C14	SOIC 14 (SMD)	Logic-IC 74C...
2	L150, L151	100uH	1210 (SMD)	Inductor
1	N170	LM2904	SOIC 8 (SMD)	Operational Amplifier
6	R111, R112, R113, R201, R211, R212, R 213	0,51Ohm	Melf (SMD)	2%
2	R157, R171	15,0KOhm	0603 (SMD)	1%
1	R158	10,0Ohm	0603 (SMD)	1%
2	R163, R263	10,0KOhm	MiniMelf (SMD)	1%
3	R170, R174, R176	30,1KOhm	0603 (SMD)	1%
1	R175	5,62KOhm	MiniMelf (SMD)	1%
1	R177	3,01KOhm	1206 (SMD)	1%
3	R27, R178, R179	0,00Ohm	MiniMelf (SMD)	
3	R28, R50, R52	10,0KOhm	MicroMelf (SMD)	1%
6	R30, R31, R32, R33, R34, R37	5,11KOhm	MicroMelf (SMD)	1%
1	R36	3,32KOhm	0603 (SMD)	1%
2	R43, R45	0,00Ohm	0603 (SMD)	
3	R47, R54, R56	10,0KOhm	0603 (SMD)	1%
1	R51	121KOhm	0603 (SMD)	1%
1	R53	100Ohm	MicroMelf (SMD)	1%
1	R57	1,50KOhm	MicroMelf (SMD)	1%
1	R58	1,00KOhm	0603 (SMD)	1%
2	R60, R61	2,00KOhm	0603 (SMD)	1%
1	R62	3,92KOhm	0603 (SMD)	1%
6	V111, V112, V113, V211, V212, V213	10BQ100	SMB (SMD)	Diode Schottky
2	V150, V250	BY203/20S	SMD	High Voltage Diode
2	V170, V171	BAV70W	SOT323 (SMD)	Double Diode
1	V20	SMCJ15	DO214AB (SMD)	Suppressor Diode
5	V23, V25, V26, V27, V29	BC847B	SOT23 (SMD)	NPN-Transistor
1	V28	BZX284-C7V5	SOD110 (SMD)	Zener-Diode
1	X20	20p.	SMD	Connector
4	X6, X7, X10, X11	RM2,54 10p.	SMD	Box Connector

TP: Test Point
Box Connector: SUYIN 254100FA010G200ZU

DISCLAIMER

SEMIKRON reserves the right to make changes without further notice herein to improve reliability, function or design. Information furnished in this document is believed to be accurate and reliable. However, no representation or warranty is given and no liability is assumed with respect to the accuracy or use of such information. SEMIKRON does not assume any liability arising out of the application or use of any product or circuit described herein. Furthermore, this technical information may not be considered as an assurance of component characteristics. No warranty or guarantee expressed or implied is made regarding delivery, performance or suitability. This document supersedes and replaces all information previously supplied and may be superseded by updates without further notice.

SEMIKRON products are not authorized for use in life support appliances and systems without the express written approval by SEMIKRON.