

High Power Diode Modules

$I_{FRSM} = 2x\ 350\ A$
 $I_{FAVM} = 2x\ 224\ A$
 $V_{RRM} = 1400-2200\ V$

V_{RSM} V	V_{RRM} V	Type
1500	1400	MDD 200-14N1
1700	1600	MDD 200-16N1
1900	1800	MDD 200-18N1
2300	2200	MDD 200-22N1

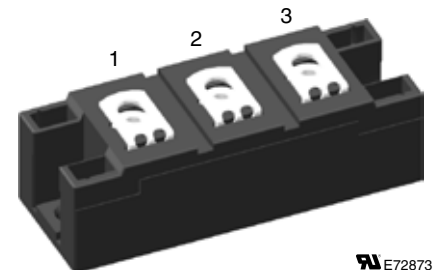
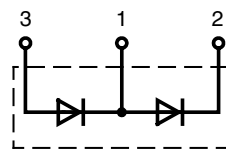

E72873

Symbol	Conditions	Maximum Ratings
I_{FRMS}	$T_{VJ} = T_{VJM}$	350 A
I_{FAVM}	$T_C = 100^\circ C$; 180° sine	224 A
I_{FSM}	$T_{VJ} = 45^\circ C$; $t = 10\ ms$ (50 Hz)	10500 A
	$V_R = 0$; $t = 8.3\ ms$ (60 Hz)	11200 A
	$T_{VJ} = T_{VJM}$; $t = 10\ ms$ (50 Hz)	9100 A
	$V_R = 0$; $t = 8.3\ ms$ (60 Hz)	9700 A
I^2t	$T_{VJ} = 45^\circ C$; $t = 10\ ms$ (50 Hz)	551000 A ² s
	$V_R = 0$; $t = 8.3\ ms$ (60 Hz)	527000 A ² s
	$T_{VJ} = T_{VJM}$; $t = 10\ ms$ (50 Hz)	414000 A ² s
	$V_R = 0$; $t = 8.3\ ms$ (60 Hz)	395000 A ² s
T_{VJ}		-40...+150 °C
T_{VJM}		150 °C
T_{stg}		-40...+125 °C
V_{ISOL}	50/60 Hz, RMS $t = 1\ min$	3000 V~
	$I_{ISOL} \leq 1\ mA$ $t = 1\ s$	3600 V~
M_d	Mounting torque (M6)	2.25 - 2.75 Nm
	Terminal connection torque (M6)	4.5 - 5.5 Nm
Weight	Typical including screws	120 g

Features

- International standard package
- Direct copper bonded Al_2O_3 ceramic with copper base plate
- Planar passivated chips
- Isolation voltage 3600 V~

Applications

- Supplies for DC power equipment
- DC supply for PWM inverter
- Field supply for DC motors
- Battery DC power supplies

Advantages

- Space and weight savings
- Simple mounting
- Improved temperature and power cycling
- Reduced protection circuits

Dimensions in mm (1 mm = 0.0394")

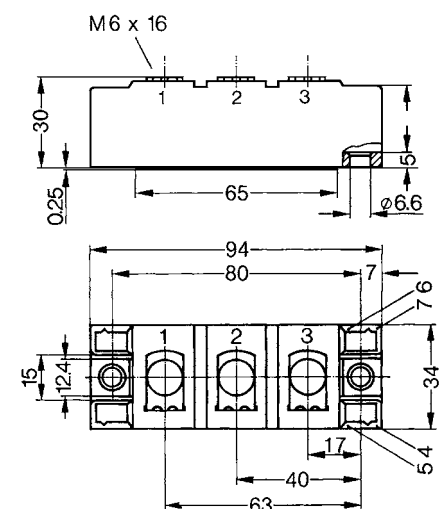

Symbol	Conditions	Characteristics Values
I_{RRM}	$V_R = V_{RRM}$; $T_{VJ} = T_{VJM}$	20 mA
V_F	$I_F = 300\ A$; $T_{VJ} = 25^\circ C$	1.3 V
V_{T0}	For power-loss calculations only	0.8 V
r_t	$T_{VJ} = T_{VJM}$	0.6 mΩ
R_{thJC}	per diode; DC current	0.130 K/W
	per module	0.065 K/W
R_{thJK}	per diode; DC current	0.230 K/W
	per module	0.115 K/W
Q_S	$T_{VJ} = 125^\circ C$; $I_F = 300\ A$; $-di/dt = 50\ A/\mu s$	625 μC
I_{RM}		275 A
d_s	Creeping distance on surface	12.7 mm
d_A	Creepage distance in air	9.6 mm
a	Maximum allowable acceleration	50 m/s ²

Data according to IEC 60747 and refer to a single diode unless otherwise stated.

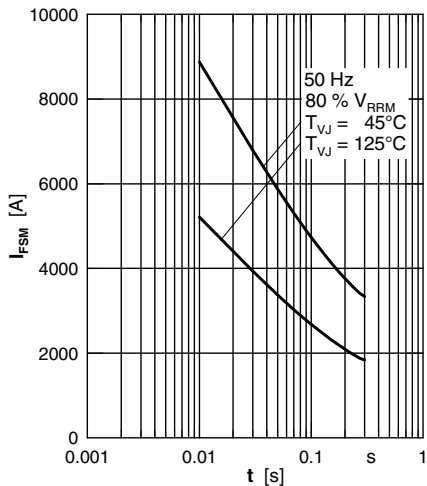

Fig. 1 Surge overload current I_{FSM} : Crest value, t: duration

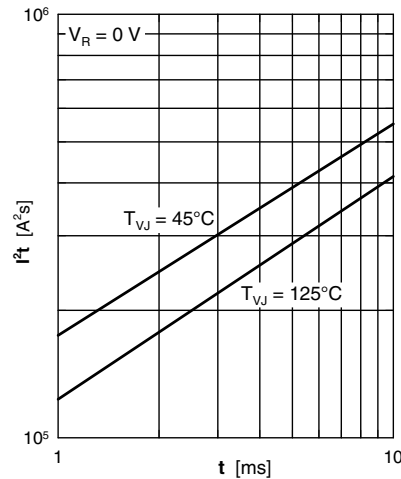

Fig. 2 I^2t versus time (1-10 ms)

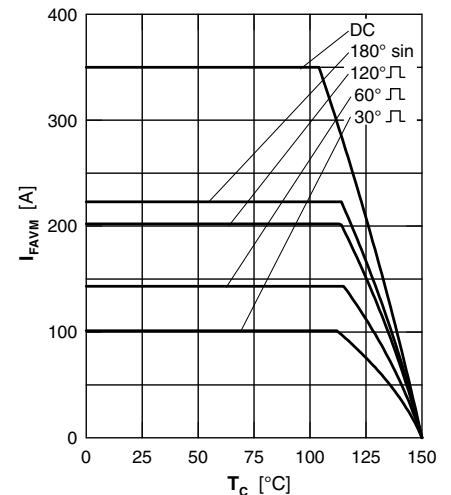

Fig. 3 Maximum forward current at case temperature

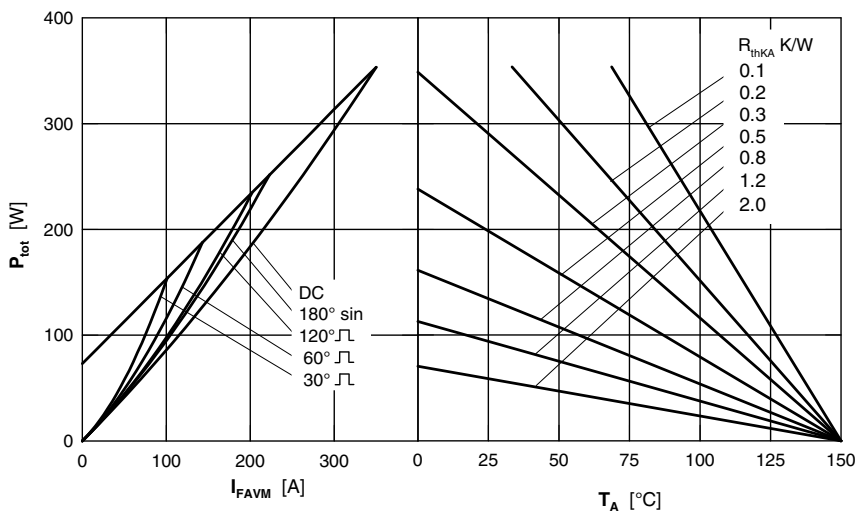

Fig. 4 Power dissipation versus forward current and ambient temperature (per diode)

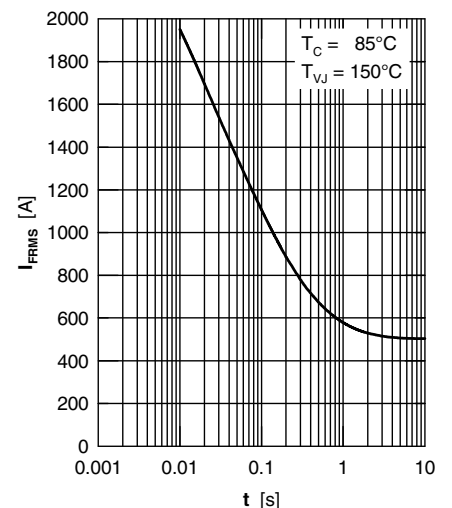

Fig. 5 Rated RMS current versus time (360° conduction)

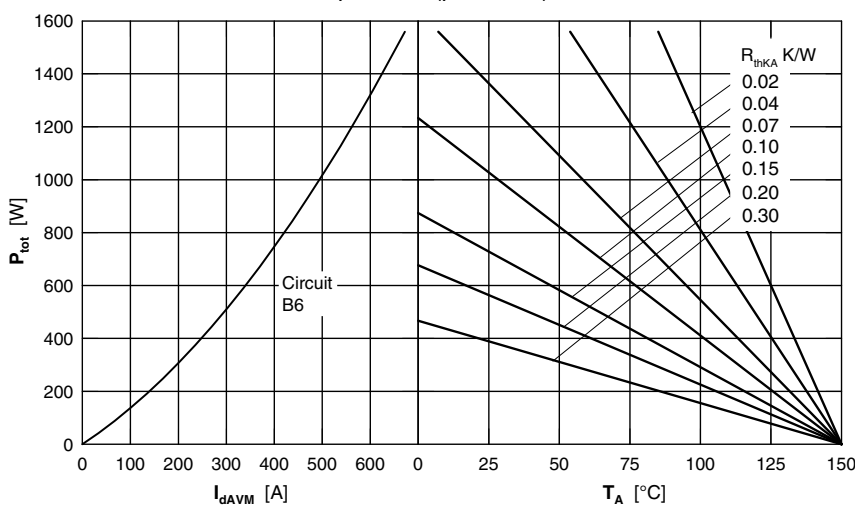

Fig. 6 Three phase rectifier bridge: Power dissipation versus direct output current and ambient temperature

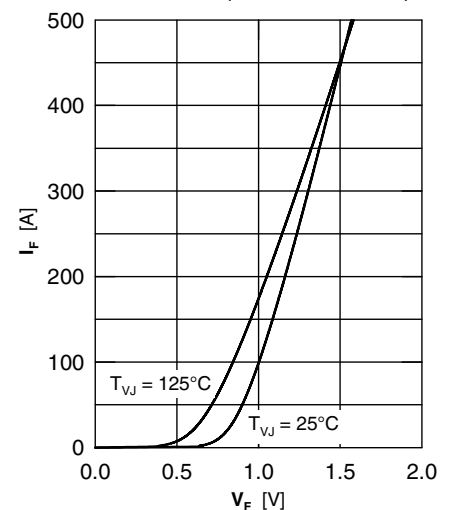

Fig. 7 Forward current versus voltage drop

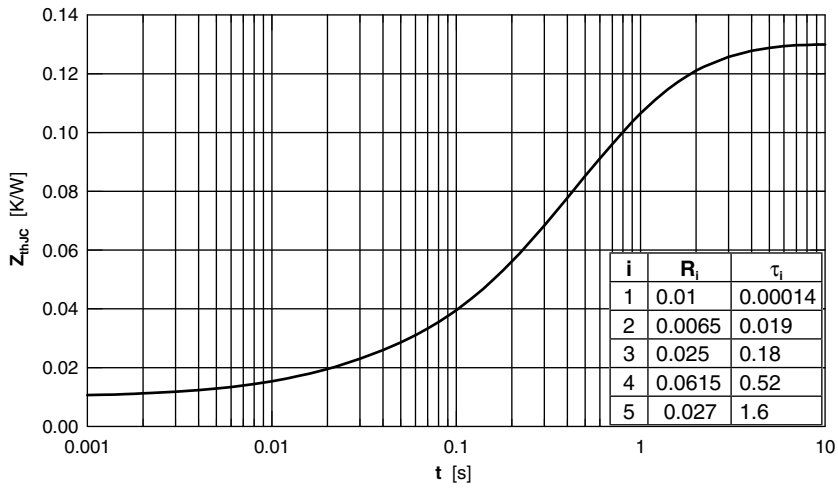

Fig. 8 Transient thermal impedance junction to case