

Thyristor \ Diode Module

 $V_{RRM} = 2 \times 1800 \text{ V}$
 $I_{TAV} = 110 \text{ A}$
 $V_T = 1.21 \text{ V}$

Phase leg

Part number

MCMA110PD1800TB

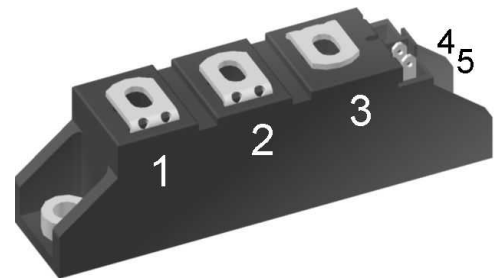

Backside: isolated

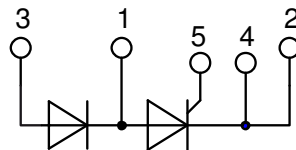

Features / Advantages:

- Thyristor for line frequency
- Planar passivated chip
- Long-term stability
- Direct Copper Bonded Al₂O₃-ceramic

Applications:

- Line rectifying 50/60 Hz
- Softstart AC motor control
- DC Motor control
- Power converter
- AC power control
- Lighting and temperature control

Package: TO-240AA

- Isolation Voltage: 4800 V~
- Industry standard outline
- RoHS compliant
- Soldering pins for PCB mounting
- Base plate: DCB ceramic
- Reduced weight
- Advanced power cycling

Terms Conditions of usage:

The data contained in this product data sheet is exclusively intended for technically trained staff. The user will have to evaluate the suitability of the product for the intended application and the completeness of the product data with respect to his application. The specifications of our components may not be considered as an assurance of component characteristics. The information in the valid application- and assembly notes must be considered. Should you require product information in excess of the data given in this product data sheet or which concerns the specific application of your product, please contact your local sales office.

Due to technical requirements our product may contain dangerous substances. For information on the types in question please contact your local sales office.

Should you intend to use the product in aviation, in health or life endangering or life support applications, please notify. For any such application we urgently recommend

- to perform joint risk and quality assessments;

- the conclusion of quality agreements;

- to establish joint measures of an ongoing product survey, and that we may make delivery dependent on the realization of any such measures.

Rectifier			Ratings			
Symbol	Definition	Conditions	min.	typ.	max.	Unit
$V_{RSM/DSM}$	max. non-repetitive reverse/forward blocking voltage	$T_{VJ} = 25^{\circ}C$			1900	V
$V_{RRM/DRM}$	max. repetitive reverse/forward blocking voltage	$T_{VJ} = 25^{\circ}C$			1800	V
I_{RD}	reverse current, drain current	$V_{R/D} = 1800 V$	$T_{VJ} = 25^{\circ}C$		100	μA
		$V_{R/D} = 1800 V$	$T_{VJ} = 140^{\circ}C$		10	mA
V_T	forward voltage drop	$I_T = 110 A$	$T_{VJ} = 25^{\circ}C$		1.24	V
		$I_T = 220 A$			1.52	V
		$I_T = 110 A$	$T_{VJ} = 125^{\circ}C$		1.21	V
		$I_T = 220 A$			1.57	V
I_{TAV}	average forward current	$T_C = 85^{\circ}C$	$T_{VJ} = 140^{\circ}C$		110	A
$I_{T(RMS)}$	RMS forward current	180° sine			170	A
V_{T0}	threshold voltage	} for power loss calculation only	$T_{VJ} = 140^{\circ}C$		0.85	V
r_T	slope resistance				3.3	m Ω
R_{thJC}	thermal resistance junction to case				0.3	K/W
R_{thCH}	thermal resistance case to heatsink			0.20		K/W
P_{tot}	total power dissipation		$T_C = 25^{\circ}C$		380	W
I_{TSM}	max. forward surge current	$t = 10 ms; (50 Hz), sine$	$T_{VJ} = 45^{\circ}C$		1.90	kA
		$t = 8,3 ms; (60 Hz), sine$	$V_R = 0 V$		2.05	kA
		$t = 10 ms; (50 Hz), sine$	$T_{VJ} = 140^{\circ}C$		1.62	kA
		$t = 8,3 ms; (60 Hz), sine$	$V_R = 0 V$		1.75	kA
I^2t	value for fusing	$t = 10 ms; (50 Hz), sine$	$T_{VJ} = 45^{\circ}C$		18.1	kA ² s
		$t = 8,3 ms; (60 Hz), sine$	$V_R = 0 V$		17.5	kA ² s
		$t = 10 ms; (50 Hz), sine$	$T_{VJ} = 140^{\circ}C$		13.0	kA ² s
		$t = 8,3 ms; (60 Hz), sine$	$V_R = 0 V$		12.7	kA ² s
C_J	junction capacitance	$V_R = 400 V f = 1 MHz$	$T_{VJ} = 25^{\circ}C$		95	pF
P_{GM}	max. gate power dissipation	$t_p = 30 \mu s$	$T_C = 140^{\circ}C$		10	W
		$t_p = 300 \mu s$			5	W
P_{GAV}	average gate power dissipation				0.5	W
$(di/dt)_{cr}$	critical rate of rise of current	$T_{VJ} = 140^{\circ}C; f = 50 Hz$ repetitive, $I_T = 330 A$			150	A/ μs
		$t_p = 200 \mu s; di_G/dt = 0.45 A/\mu s;$ $I_G = 0.45 A; V = \frac{2}{3} V_{DRM}$ non-repet., $I_T = 110 A$			500	A/ μs
$(dv/dt)_{cr}$	critical rate of rise of voltage	$V = \frac{2}{3} V_{DRM}$	$T_{VJ} = 140^{\circ}C$		1000	V/ μs
		$R_{GK} = \infty$; method 1 (linear voltage rise)				
V_{GT}	gate trigger voltage	$V_D = 6 V$	$T_{VJ} = 25^{\circ}C$		1.5	V
			$T_{VJ} = -40^{\circ}C$		1.6	V
I_{GT}	gate trigger current	$V_D = 6 V$	$T_{VJ} = 25^{\circ}C$		150	mA
			$T_{VJ} = -40^{\circ}C$		200	mA
V_{GD}	gate non-trigger voltage	$V_D = \frac{2}{3} V_{DRM}$	$T_{VJ} = 140^{\circ}C$		0.2	V
I_{GD}	gate non-trigger current				10	mA
I_L	latching current	$t_p = 10 \mu s$	$T_{VJ} = 25^{\circ}C$		200	mA
		$I_G = 0.45 A; di_G/dt = 0.45 A/\mu s$				
I_H	holding current	$V_D = 6 V R_{GK} = \infty$	$T_{VJ} = 25^{\circ}C$		200	mA
t_{gd}	gate controlled delay time	$V_D = \frac{1}{2} V_{DRM}$	$T_{VJ} = 25^{\circ}C$		2	μs
		$I_G = 0.45 A; di_G/dt = 0.45 A/\mu s$				
t_q	turn-off time	$V_R = 100 V; I_T = 110 A; V = \frac{2}{3} V_{DRM}$ $di/dt = 10 A/\mu s dv/dt = 20 V/\mu s t_p = 200 \mu s$	$T_{VJ} = 125^{\circ}C$		185	μs

Package TO-240AA				Ratings			
Symbol	Definition	Conditions	min.	typ.	max.	Unit	
I_{RMS}	RMS current	per terminal			200	A	
T_{VJ}	virtual junction temperature		-40		140	°C	
T_{op}	operation temperature		-40		125	°C	
T_{stg}	storage temperature		-40		125	°C	
Weight					81	g	
M_D	mounting torque		2.5		4	Nm	
M_T	terminal torque		2.5		4	Nm	
$d_{Spp/App}$	creepage distance on surface striking distance through air	terminal to terminal	13.0	9.7		mm	
$d_{Spb/Apb}$		terminal to backside	16.0	16.0		mm	
V_{ISOL}	isolation voltage	t = 1 second		4800		V	
		t = 1 minute	50/60 Hz, RMS; $I_{ISOL} \leq 1$ mA	4000		V	

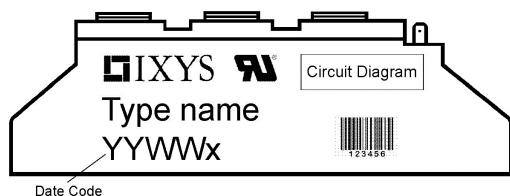
Part description

- M = Module
- C = Thyristor (SCR)
- M = Thyristor
- A = (up to 1800V)
- 110 = Current Rating [A]
- PD = Phase leg
- 1800 = Reverse Voltage [V]
- TB = TO-240AA-1B

Ordering	Ordering Number	Marking on Product	Delivery Mode	Quantity	Code No.
Standard	MCMA110PD1800TB	MCMA110PD1800TB	Box	36	

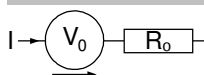
Equivalent Circuits for Simulation
** on die level*
 $T_{VJ} = 140\text{ °C}$

Thyristor

$V_{0\ max}$	threshold voltage	0.85	V
$R_{0\ max}$	slope resistance *	2.1	mΩ

Outlines TO-240AA

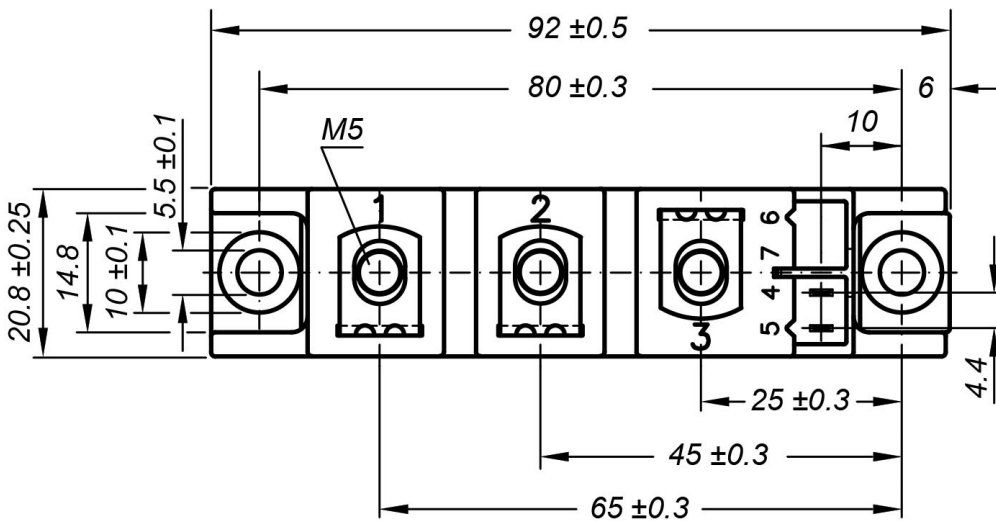

General tolerance: DIN ISO 2768 class „c“



Optional accessories: Keyed gate/cathode twin plugs
 Wire length: 350 mm, gate = white, cathode = red
 UL 758, style 3751
 Type **ZY 200L** (L = Left for pin pair 4/5)



Thyristor

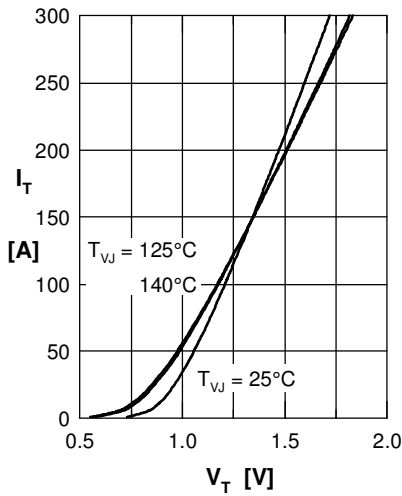

Fig. 1 Forward characteristics

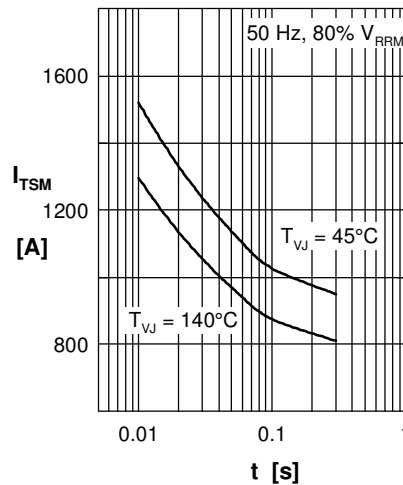

Fig. 2 Surge overload current
 I_{TSM} : crest value, t : duration

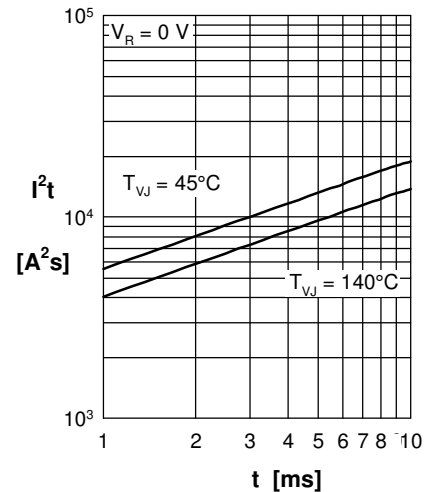

Fig. 3 I^2t versus time (1-10 s)

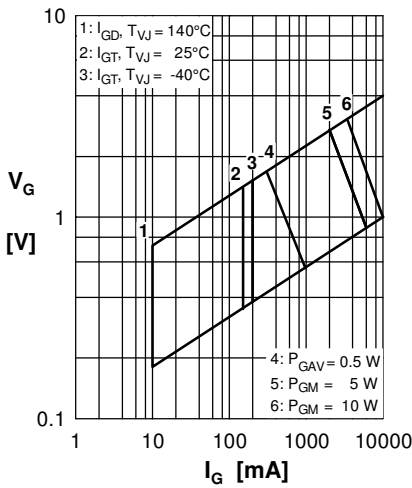

Fig. 4 Gate voltage & gate current

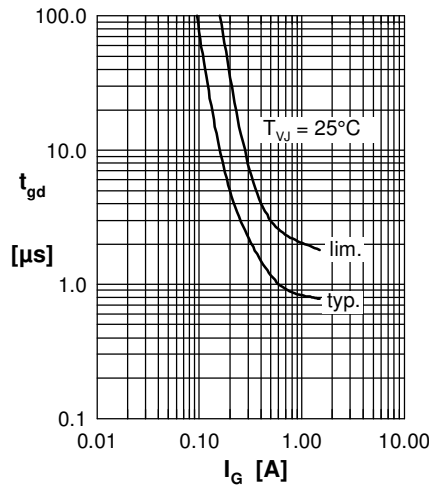

Fig. 5 Gate controlled delay time t_{gd}

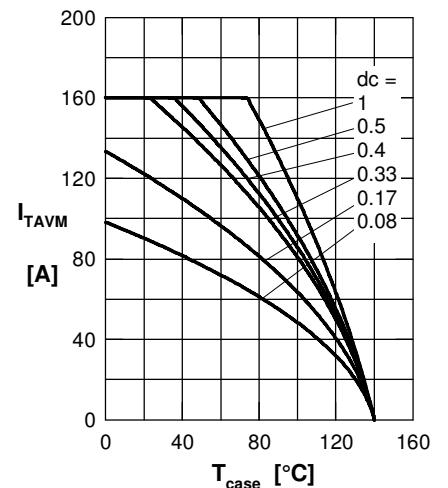

Fig. 6 Max. forward current at case temperature

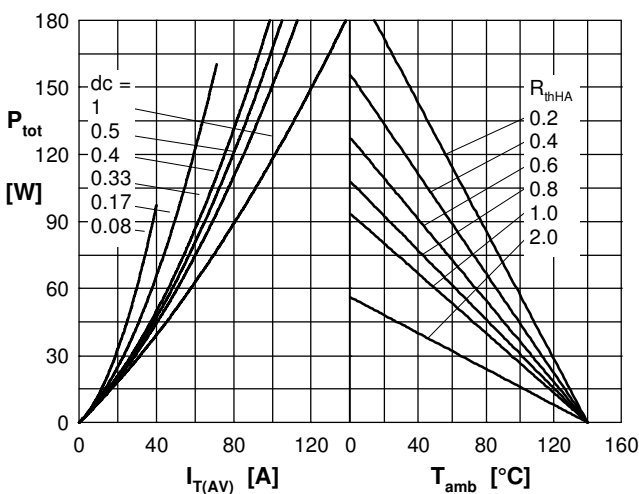

Fig. 7a Power dissipation versus direct output current
Fig. 7b and ambient temperature

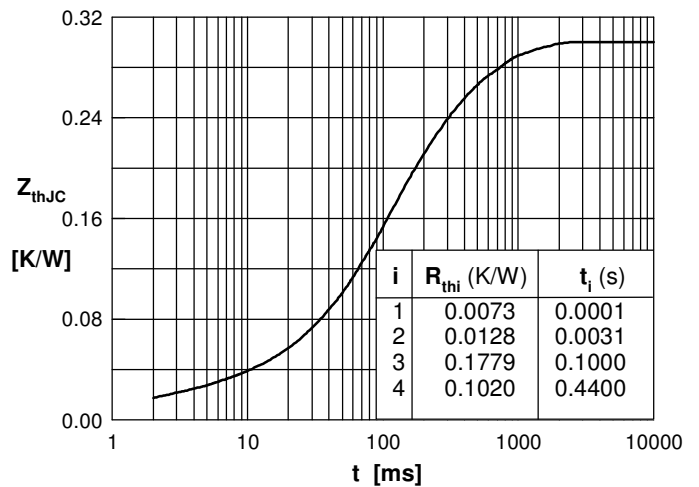

Fig. 8 Transient thermal impedance junction to case