

Three Phase Rectifier Bridge

$I_{dAV} = 248 \text{ A}$
 $V_{RRM} = 800-1800 \text{ V}$

V_{RSM} V	V_{RRM} V	Type
800	800	VUO 190-08NO7
1200	1200	VUO 190-12NO7
1400	1400	VUO 190-14NO7
1600	1600	VUO 190-16NO7
1800	1800	VUO 190-18NO7*

* delivery time on request

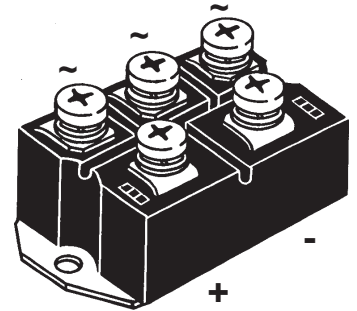
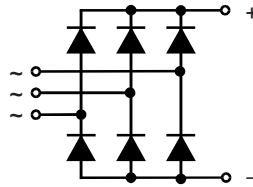

Symbol	Test Conditions	Maximum Ratings	
I_{dAV}	$T_C = 100^\circ\text{C}$, module	248	A
I_{dAV}	$T_A = 35^\circ\text{C}$ ($R_{thCA} = 0.2 \text{ K/W}$), module	165	A
I_{FSM}	$T_{VJ} = 45^\circ\text{C};$ $V_R = 0$	$t = 10 \text{ ms}$ (50 Hz), sine	2800 A
		$t = 8.3 \text{ ms}$ (60 Hz), sine	3300 A
	$T_{VJ} = T_{VJM}$ $V_R = 0$	$t = 10 \text{ ms}$ (50 Hz), sine	2500 A
		$t = 8.3 \text{ ms}$ (60 Hz), sine	2750 A
I^2t	$T_{VJ} = 45^\circ\text{C}$ $V_R = 0$	$t = 10 \text{ ms}$ (50 Hz), sine	39 200 A ² s
		$t = 8.3 \text{ ms}$ (60 Hz), sine	45 000 A ² s
	$T_{VJ} = T_{VJM}$ $V_R = 0$	$t = 10 \text{ ms}$ (50 Hz), sine	31 200 A ² s
		$t = 8.3 \text{ ms}$ (60 Hz), sine	31 300 A ² s
T_{VJ}		-40...+150	°C
T_{VJM}		150	°C
T_{stg}		-40...+125	°C
V_{ISOL}	50/60 Hz, RMS $I_{ISOL} \leq 1 \text{ mA}$	$t = 1 \text{ min}$	2500 V~
		$t = 1 \text{ s}$	3000 V~
M_d	Mounting torque (M6)	$5 \pm 15 \%$	Nm
	Terminal connection torque (M6)	$5 \pm 15 \%$	Nm
Weight	typ.	270	g

Features

- Package with screw terminals
- Isolation voltage 3000 V~
- Planar passivated chips
- Blocking voltage up to 1800 V
- Low forward voltage drop
- UL registered E72873

Applications

- Supplies for DC power equipment
- Input rectifiers for PWM inverter
- Battery DC power supplies
- Field supply for DC motors

Advantages

- Easy to mount with two screws
- Space and weight savings
- Improved temperature and power cycling

Dimensions in mm (1 mm = 0.0394")

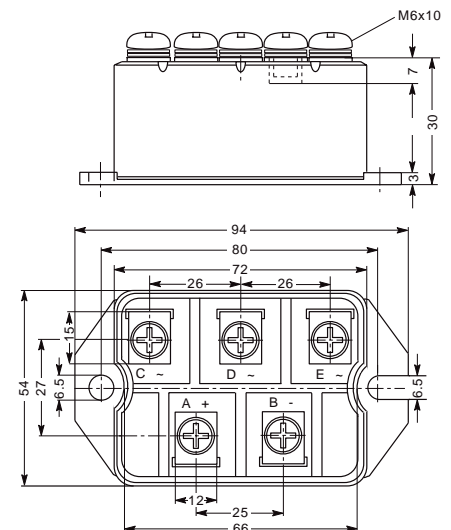

Data according to IEC 60747 and refer to a single diode unless otherwise stated
 IXYS reserves the right to change limits, test conditions and dimensions.

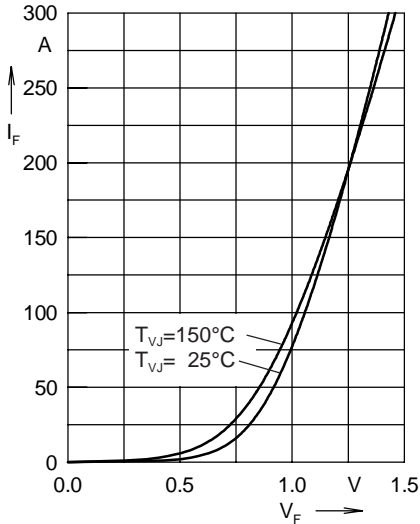

Fig. 4 Forward current versus voltage drop per diode

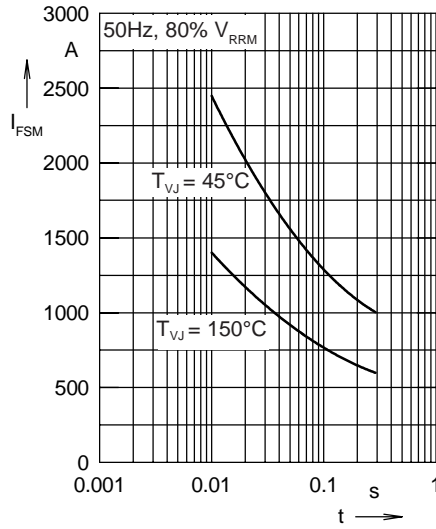

Fig. 5 Surge overload current

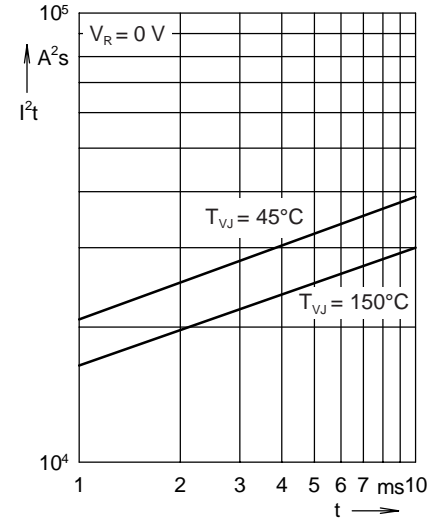

Fig. 6 I^2t versus time per diode

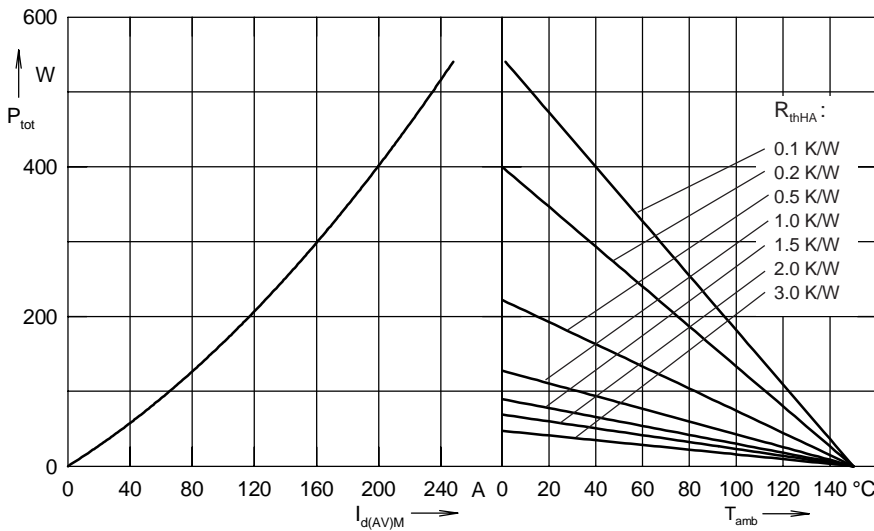

Fig. 7 Power dissipation versus direct output current and ambient temperature

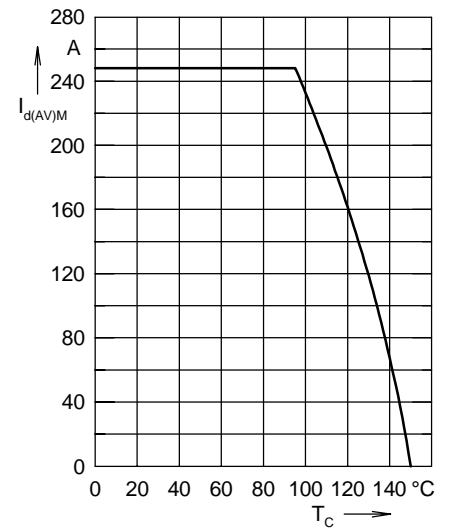

Fig. 8 Max. forward current versus case temperature

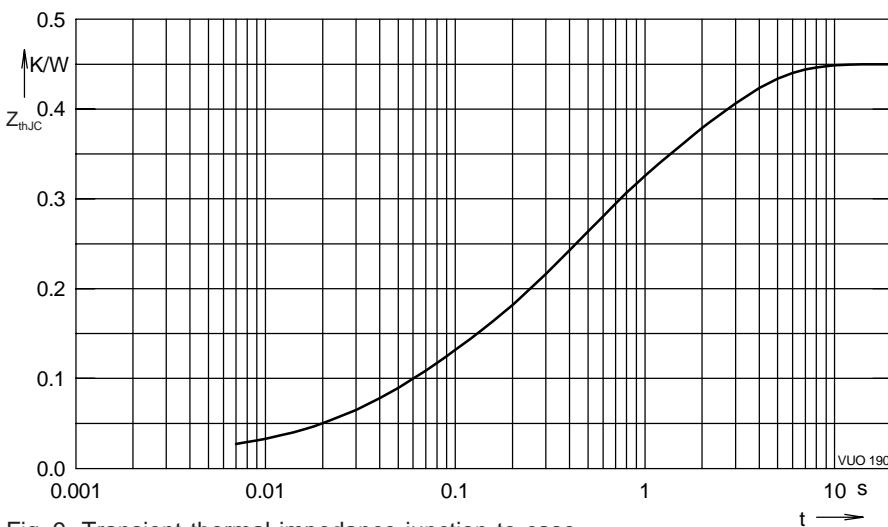

Fig. 9 Transient thermal impedance junction to case

Constants for Z_{thJC} calculation:

i	R_{thi} (K/W)	t_i (s)
1	0.013	0.0012
2	0.072	0.047
3	0.175	0.326
4	0.19	2.03